

# Western Dam Engineering Technical Note

A QUARTERLY PUBLICATION FOR WESTERN DAM ENGINEERS

In this issue of the *Western Dam Engineering Technical Note*, we present articles on shear strength testing, reservoir outlet considerations, and some lessons learned from the September 2013 Colorado flood event. This quarterly newsletter is meant as an educational resource for civil engineers who practice primarily in rural areas of the western United States. This publication focuses on technical articles specific to the design, inspection, safety, and construction of small dams. It provides general information. The reader is encouraged to use the references cited and engage other technical experts as appropriate.

## GOOD TO KNOW

### Comments/Feedback/Suggestions?

Email [Colorado Dam Safety](mailto:Colorado Dam Safety) to submit feedback on Articles. Please use article title as the subject of the email.

### Upcoming ASDSO Webinar Dam Safety Training:

- *Foundation Preparation During Dam Construction*, by John France, P.E., October 14, 2014
- *Rehabilitation of Concrete Dams*, by Robert Kline, P.E., November 12, 2014
- *Earthquake Hazards and Ground Motions*, by Lelio Mejia, Ph.D., P.E., and William Fraser, December 9, 2014

### Upcoming Classroom Technical Seminars:

- *Inspection and Assessment of Dams*, November 5-7, 2014 Austin, TX

[ASDSO Training Website Link](#)

The Western Dam Engineering Technical Note is sponsored by the following agencies:

- ◆ [Colorado Division of Water Resources](#)
- ◆ [Montana Department of Natural Resources](#)
- ◆ [Wyoming State Engineer's Office](#)

This news update was compiled, written, and edited by URS Corporation in Denver, Colorado

Funding for the News Update has been provided by the FEMA National Dam Safety Act Assistance to States grant program.

### Article Contributors:

URS Corporation: Julie Heitland; Fernando Castaneda, PE; Ed Villano, PE; Jennifer Williams, PE; Jason Boomer, PE; John France, PE

### Editorial Review Board:

Michele Lemieux, PE, Montana Dam Safety Program Supervisor; Bill McCormick, PE, PG, Colorado Chief Dam Safety Branch; Mike Hand, PE, Wyoming Dam Safety Program; Mark Ogden, PE, Association of State Dam Safety Officials; Matthew Lindon, PE, Loughlin Water Associates; and Steve Becker, PE, Natural Resources Conservation Service

The material in this publication has been prepared in accordance with generally recognized engineering principles and practices, and is for general information only. The information presented should not be used without first securing competent advice from qualified professionals with respect to its suitability for any general or specific application. No reference made in this publication constitutes an endorsement or warranty thereof by URS Corporation or sponsors of this newsletter. Anyone using the information presented in this newsletter assumes all liability arising from such use.

## In this Issue

Introduction.....	1	How Low Can You Go? The Needs and Considerations for Outlets.....	13
Soil Characterization (Part 2) – Laboratory and Field Shear Strength Testing.....	2	Dam Overtopping Failures – Lessons Learned from the September 2013 Colorado Flood Event.....	19

### Soil Characterization (Part 2) – Laboratory and Field Shear Strength Testing

#### Introduction

This article presents discussions of the various types of laboratory and field testing for evaluating the shear strength of cohesionless (sands and gravels) and cohesive (clays and silts) soils.

A subsequent article (Part 3) on shear strength characterization will elaborate on utilizing laboratory and field testing results to select and develop shear strength parameters for use in embankment dam slope stability analyses.

#### Previous Articles

The fundamentals of soil characterization for dams, including some introductory aspects of shear strength characterization, were presented in the July 2014 issue of the *Western Dam Engineering* newsletter in an article titled "[Soil Characterization \(Part 1\) – Here's the Dirt.](#)" That article presented a broad overview of properties pertinent to the overall performance and analysis of dams.

Additionally, the fundamentals of slope stability analyses were presented in the November 2013 newsletter issue in an article titled "[Embankment Dam Slope Stability 101](#)," where the topic of shear strength characterization for slope stability analysis was introduced. Discussion was also provided on slope stability modeling for the following embankment loading conditions: steady state, end of construction, rapid drawdown, and seismic.

You are invited to revisit and review those two articles, as this article builds on many of the concepts presented in the previous articles.

#### What this Article Does Not Cover

This article does not discuss shear strength testing of rock or special soils such as cemented sands, stiff fissured clays, highly sensitive ("quick") clays, and organic soils; the discussion is limited to the most common soils used in dam engineering and construction.

### Undrained vs. Drained Conditions and Total vs. Effective Stresses

In this section, the concepts of undrained loading conditions versus drained loading conditions and total stress versus effective stress testing and analysis methods are introduced. An understanding of these concepts is important in evaluating soil behavior and assigning appropriate shear strengths.

When saturated or partially saturated soils are loaded in shear, they have a tendency to change in volume. Loose sands or normally consolidated clays tend to decrease in volume, while dense sands or overconsolidated clays tend to increase in volume. If the loading is applied slowly enough, pore water will flow into or out of the soil mass, the volume of the soil mass will change, and pore pressures will not change. However, if the loading is applied more quickly than drainage can occur, pore water pressures will be generated within the soil mass. Positive pore pressures will generate in loose sands or normally consolidated clays due to the tendency to compress, while negative pore pressures will generate in dense or overconsolidated clays due to the tendency to expand. Coarse-grained soils (sands and gravels) have high hydraulic conductivities (permeabilities) and sufficient drainage capacity to prevent pore water pressures from changing for most loadings (earthquake loading being an exception that is beyond the scope of this article), while fine-grained soils (clays and silts) have low hydraulic conductivities and can develop excess pore water pressures during some static loading conditions.

Undrained conditions occur when loading is applied more rapidly than soil drainage can occur. Under undrained conditions, water cannot flow into or out of the soil in the length of time the loading is applied. As a result, pore water pressures increase or decrease in response to changes in load, as described above. Drained conditions occur when loading is applied slowly enough relative to the permeability of the soil that drainage of pore water can occur. Pore water pressures do not change under drained loading conditions, because water can move into or out of the soil freely in response to changes in load.

Hence, whether a particular loading should be considered undrained or drained is dependent on rate of loading, soil permeability, and the distance over which drainage must occur to prevent pore water pressure changes. One method for estimating whether a soil will behave in a drained or undrained manner during loading is presented in the article "[Embankment Dam Slope Stability 101](#)" from the November 2013 newsletter. Alternatively, soils having a coefficient of permeability greater than approximately  $1 \times 10^{-3}$  centimeters per second (cm/s) can be considered to be free-draining under static loading, as a general rule of thumb (Duncan and Wright, 2005). Although conditions can be intermediate between undrained and drained, loading conditions are almost always modeled as either one or the other. In some cases, when it is not clear whether the loading conditions are undrained or drained, both cases are considered in the analysis.

Total stresses within a soil mass include both stresses resulting from forces transmitted through interparticle contacts and pore water pressures. Effective stresses within a soil mass include only stresses resulting from the forces transmitted through interparticle contacts. At any given location, the effective stress equals the total stress minus the pore water pressure.

Soil strengths can be defined as a function of either total stresses or effective stresses. When strengths defined in terms of total stress are used in stability analysis, the approach is commonly called the total stress method, while the term effective stress method is used when strengths defined in terms of effective stress are used in stability analysis. Effective stress methods should always be used for drained loading conditions. For undrained loading, one needs to choose between total stress methods and effective stress methods. Total stress methods are used when it is easier to predict the strength during undrained loading than it is to predict the pore water pressures during undrained loading, which is almost always the case.

Soil strengths are always governed by effective stresses, or interparticle forces, regardless of loading condition. Total stress strength characterizations are simply used in those cases where we cannot easily

predict pore water pressure responses and we can more easily predict the undrained strength. The pore water pressure is implicit in the selected total stress strength; the pore pressure is whatever value is necessary to produce an effective stress state that results in the predicted strength.

**Shear strength of a soil is controlled by effective stresses, whether failure occurs under drained or undrained conditions.**

A future article (Part 3 of the series) will provide guidance on when undrained conditions, drained conditions, total stress methods, and effective stress methods are generally used for shear strength characterization and slope stability analysis. But first, shear strength parameters and strength testing to evaluate the parameters will be discussed.

### Shear Strength Explained

Shear strength can be defined as the ability of soil to resist failure (rupture or sliding) under shear loading. The shear load is the result of gravity forces from the soil mass and any external loads (e.g. reservoir loads, equipment loads, seismic loads). Soil shear strength depends on:

- Types of soil particles and mineralogy
- Consolidation pressure
- Drainage allowed
- Stress history, including overconsolidation
- Stress paths

The most common way of representing or characterizing shear strength of soils is the Mohr-Coulomb failure criterion using the following equations:

$$S = C + \sigma \tan\phi \quad (\text{total stress})$$

$$S = C' + \sigma' \tan\phi' \quad (\text{effective stress})$$

Where  $s$  = shear strength;  $c$  = cohesion;  $\sigma$  = effective or total stress; and  $\phi$  = internal friction angle.

As represented by the Mohr-Coulomb failure criterion, the shear strength characterization for a soil consists of



a frictional component ( $\phi$ ,  $\phi'$ ) and a non-frictional component, or cohesion ( $c$ ,  $c'$ ). Figure 1 below graphically depicts the Mohr-Coulomb failure criterion.

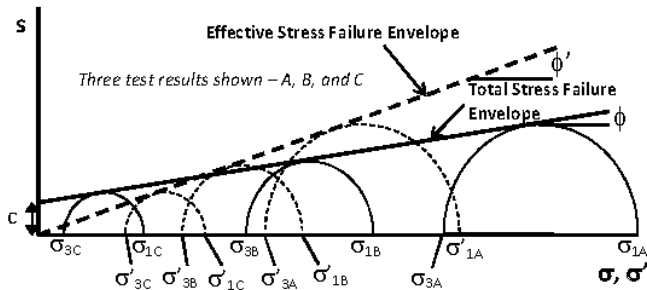

Figure 1: Mohr-Coulomb failure criterion.

Mohr-Coulomb failure envelopes can be developed through the use of Mohr's circles of stress representing the stress states at failure for a series of tests (often three tests). As seen in Figure 1, both total and effective stress failure envelopes can be developed. Failure envelopes for soils are often curved. However, for mathematical simplicity, an analyst will approximate the failure envelope as linear over the normal stress range of interest for the analysis. The Mohr-Coulomb failure criterion is, therefore, represented by a straight line (failure envelope) with a slope designated as the friction angle ( $\phi$ ,  $\phi'$ ) and an intercept called the cohesion ( $c$ ,  $c'$ ). The normal (or vertical) stress ( $\sigma$ ,  $\sigma'$ ) acting on soil in an embankment at a given depth, is represented by the horizontal axis, and can be either total stress or effective stress. Note that the greater the normal stress, the greater the frictional component and overall shear strength.

Shear strength tests are performed on soils using a range of consolidation pressures to develop the strength envelope from Mohr-Coulomb plots. The following section will discuss various laboratory tests used to evaluate the shear strength of soils, and which laboratory tests are appropriate for drained and undrained loading conditions.

### Laboratory Shear Strength Tests

The five types of laboratory tests most widely used to estimate shear strength in soils are: direct shear, unconfined compression, triaxial shear, direct simple shear, and torsional ring shear. These five tests are described in detail below and are performed in

accordance with ASTM standards. The ASTM standard for each test outlines sample preparation, failure criterion, and procedures for saturation, consolidation, loading, and pore pressure measurements (where applicable).

### Direct Shear Test

The oldest and simplest shear strength test is the direct shear (DS) test. DS testing is performed as described in ASTM D3080. In the DS test, a thin soil sample is placed in a shear box that is split horizontally into halves. A normal force ( $P_v$ ) is applied to the top of the loading head. The normal force typically ranges from 0 to 150 pounds per square inch (psi). The lower half of the box is fixed, while a shear force ( $P_h$ ) is applied to the upper half, thereby moving the upper half parallel to the lower half and forcing the soil specimen to fail along a horizontal shear plane. A schematic of the test apparatus is shown in Figure 2.

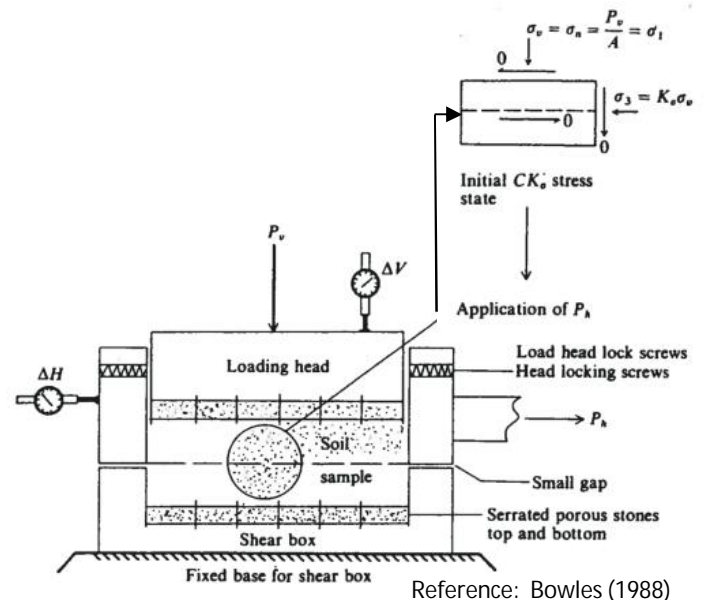

Figure 2: Direct shear test apparatus.

The DS test is performed in a strain-controlled (deformation-controlled) manner per ASTM D3080. In the strain-controlled test, a constant rate of shear displacement is applied to the top half of the box by a motor that acts through gears. Shear displacement ( $\Delta H$ ) of the top half of the box is measured by a horizontal dial gauge or displacement transducer. The resisting shear force of the soil can be measured by a horizontal proving ring or load cell. A dial gauge or displacement transducer on the upper loading plate

measures the change in height of the specimen, or vertical displacement ( $\Delta V$ ). Both peak and post-peak shear strengths can be observed in the strain-controlled test.

DS tests can only be used to accurately evaluate drained shear strength parameters. The DS test cannot accurately measure undrained strengths because constant volume conditions are not achieved, since water can be expelled from or drawn into the specimen. Since the shear plane is relatively thin, volume and moisture content changes can easily occur on the shear plane, even if the volume of the total specimen does not change. The DS test is generally applicable to grained sands, clays, and silts, because the typical DS box is too small to accommodate coarse particles. However, the test is most appropriate for dry or saturated sands. Sand has a relatively high permeability whereby excess pore water pressures generated due to loading dissipate quickly. Clays and silts have a low permeability and therefore take longer time to dissipate excess pore water pressures. As a result, the shear force must be applied very slowly for clays and silts, which can make DS testing of these soils impractical.

Generally, a minimum of three specimens are tested to establish the relation between shear stress and normal stress at failure. Typical results for a DS test are presented in Figure 3.

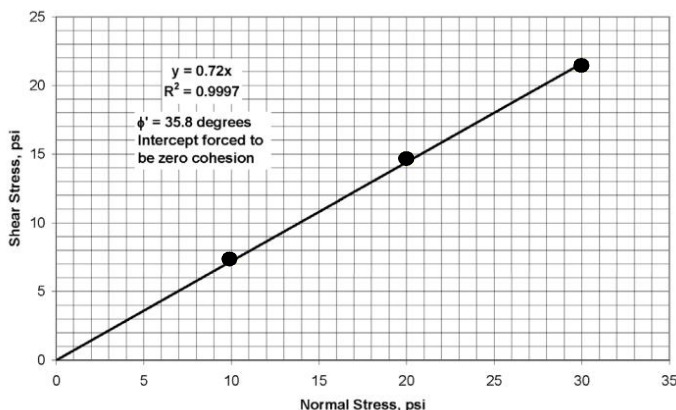

Figure 3: Typical direct shear test results.

### Unconfined Compression Test

Of the tests mentioned in this article, the quickest and least expensive is the unconfined compression (UC) test. Its use is limited to evaluating the undrained

shear strength ( $S_u$ ) of saturated cohesive soils (clays and silts). It is not suitable for dry or crumbly soil, materials with fissures or lenses, or uncemented sands and gravels. Unconfined compression testing is performed as described in ASTM D2166.

In the UC test, a laterally unsupported specimen (no horizontal confining pressure) is placed between two end plates and loaded in axial compression until shear failure occurs. The vertical load ( $P_v$ ) is applied at a rate that maintains a vertical strain of about 1 to 2 percent per minute. A schematic of the test apparatus is shown in Figure 4.



Figure 4: Unconfined compression test apparatus.

The unconfined compressive strength ( $q_u$ ) is defined as the maximum axial compressive stress at which failure occurs, or at which the axial strain reaches 15 percent if there is no sudden failure. Since there is no horizontal confining pressure, the total minor principal stress at failure ( $\sigma_3$ ) is zero and the total major principal stress at failure is equal to the unconfined compressive strength ( $\sigma_1 = q_u$ ). Thus, the undrained shear strength ( $S_u$ ) is equal to one-half of the unconfined compressive strength ( $1/2q_u$ ), as depicted in Figure 5.

The UC test can be considered a special case of the unconsolidated-undrained (UU) triaxial shear test, described subsequently, in which the lateral stress is set to zero.

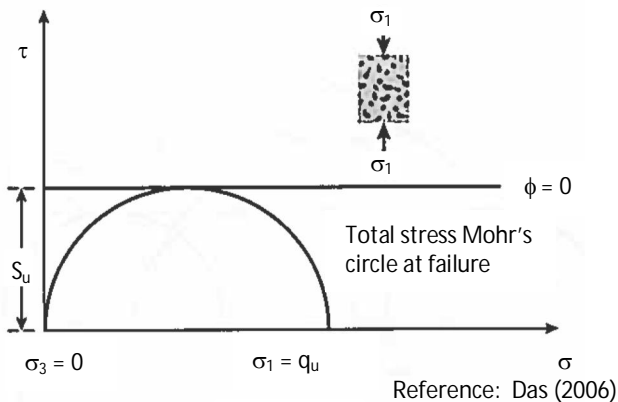

Figure 5: Unconfined compression test results.

### Triaxial Shear Test

The triaxial shear test is the most common and versatile of the five tests, but also one of the most involved and time consuming. In the triaxial test, a horizontal confining pressure is applied to the specimen and drainage conditions are controlled. The triaxial shear test can be performed on "undisturbed" samples (samples obtained from a constructed embankment or its foundation, typically using tube samplers) or remolded samples (soil samples compacted to specified design density and moisture content, e.g. to replica fill placement). Strength tests on undisturbed samples rely on the integrity of the sample being maintained during sampling, transportation, and specimen preparation. Sample disturbance can have a significant effect on strength results. Care in preserving the tube samples throughout collection, transportation, and storage is critical. Samples should be extruded only in the laboratory. The engineer needs to rely on the lab to identify signs of sample disturbance or be present during sample extrusion and specimen preparation. Triaxial shear testing is performed as described in ASTM D2850 (UU test) and D4767 (CU' test).

In the triaxial shear test, a cylindrical soil specimen is encased in a rubber membrane and placed in a triaxial test chamber that is filled with a fluid (usually water). The specimen is subjected to an all-around confining pressure laterally by pressurization of the fluid in the chamber. An axial load is applied by means of a loading piston through the top of the chamber. The confining pressure is held constant while the axial load is increased (compression testing) or decreased

(extension testing) until shear failure of the soil specimen occurs. A drainage system consisting of porous stones and drainage lines is connected to the sample on the bottom and/or top to allow for drainage and pore pressure measurement. Figure 6 illustrates the principles of the triaxial compression test. A schematic of the test apparatus is shown in Figure 7.

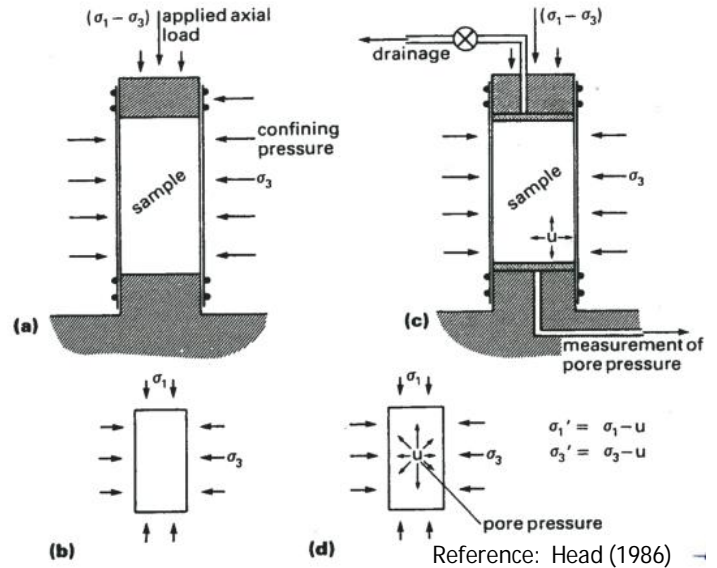

Figure 6: Principles of triaxial compression tests: (a) application of stresses, (b) representation of principal stresses, (c) usual arrangement for effective stress tests, (d) representation of total and effective stresses.

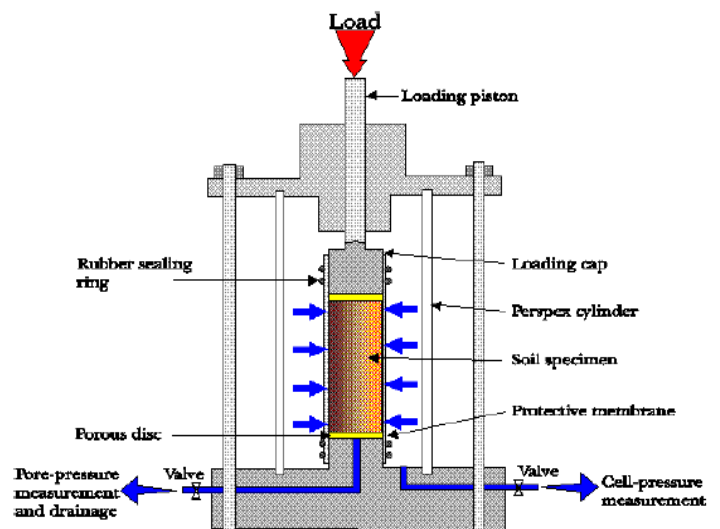

Figure 7: Triaxial shear test apparatus.

The tests are generally performed in a controlled-strain manner (specimen strained axially at a predetermined rate); usually performed at a strain rate between 0.5 and 1.25 mm/hr.

A minimum of three specimens, each under a different confining pressure, are generally tested to establish the relationship between shear stress and normal stress, which allows construction of a Mohr-Coulomb failure envelope and estimation of the shear strength parameters ( $c$ ,  $\phi$ ,  $c'$ ,  $\phi'$ ). Confining pressures should bracket the range of normal stresses expected in the field. Often, confining pressures representative of the in-situ stress state in addition to two larger stress states are specified.

Four types of triaxial tests are typically conducted:

1. Unconsolidated-Undrained (UU or Q [quick]) Test
2. Consolidated-Drained (CD or S [slow]) Test
3. Consolidated-Undrained (CU or R [rapid]) Test
4. Consolidated-Undrained (CU' or R-bar) Test with Pore Pressure Measurements

### Unconsolidated-Undrained (UU or Q) Test

In the UU test, drainage is prevented and, although a chamber pressure is applied, the soil specimen is not consolidated under a confining pressure prior to axial loading. The drainage valve remains closed during application of the confining pressure and axial loading and shearing of the specimen. The water content of the soil prior to testing remains the same during testing. Pore water pressures are not measured during the test. The UU test therefore measures total stress strength parameters ( $c$ ,  $\phi$ ) and is applicable for cohesive soils (clays and silts).

If the UU specimen is fully saturated, increasing the chamber pressure to larger total stresses will induce an equivalent increase in pore water pressure, in which case, the effective stress of the sample remains unchanged. Therefore, the measured shear strength, which is referred to as the  $\phi = 0$  strength characterization, will be the same for all chamber pressures. Some variability may occur in the resulting shear strengths due to sample variation, sample disturbance, and testing imperfections. Figure 8 illustrates idealized UU test results and the  $\phi = 0$

strength characterization. In reality, the specimens are typically not fully saturated, and there is a slight increase in shear strength with increasing chamber pressure. This is because the effective confining stresses actually increase since the pore pressure response is less than the confining pressure.

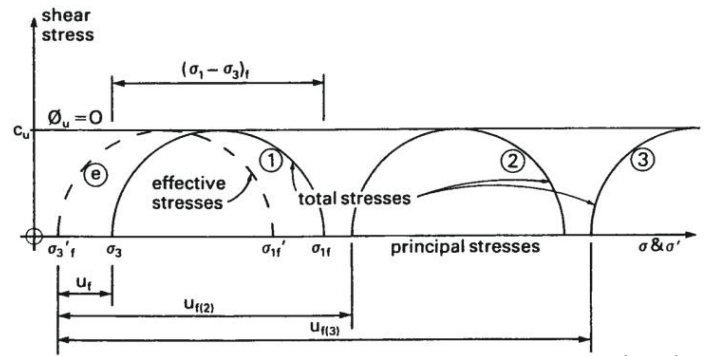

Reference: Head (1986)

Figure 8: UU test results on saturated soil.

Examples of when to perform a UU test include the following conditions: rapid loading of a slowly permeable soil, rapid construction of an embankment (or other type of loading) over a soft clay, and excavation in a soft clay.

### Consolidated-Drained (CD or S) Test

In the CD test, drainage is permitted throughout the test. The specimen is first saturated and consolidated under chamber pressure and back pressure resulting in a specified effective confining pressure. Pore water pressures generated by application of the confining pressure are allowed to dissipate until the specimen reaches its state of consolidation under the specified effective confining pressure. The CD test can be performed using either isotropically consolidated (IC-D) samples or anisotropically consolidated (AC-D) samples, in which load is applied to the piston so that the vertical consolidation load is generally higher than the lateral load.

During axial loading, the specimen is sheared to failure with an open drainage valve at a slow enough rate such that excess pore water pressures dissipate during the test. The pore water volume change (either a decrease or increase) is measured during the shear stage of the test. The CD test therefore evaluates drained effective stress strength parameters ( $c'$ ,  $\phi'$ ). Effective stress strength parameters for moist samples are often assumed to be the same as that for saturated



samples. This is conservative, but eliminates the need to perform moist CD tests, which are very complex. The CD test is applicable for both cohesionless soils (sands and gravels) and cohesive soils (clays and elastic silts), however the shear strain rates required for cohesive soils may be so slow as to be impractical, particularly considering that effective stress parameters for these soils can be obtained in a CU' test, as discussed below. Refer to Figure 9 for the failure envelope corresponding to a CD test.

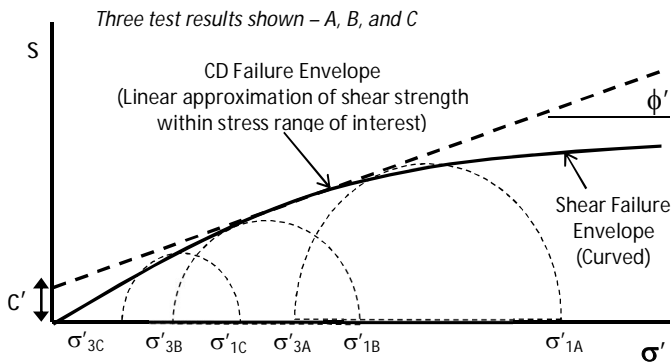

Figure 9: CD test results. [Curved shear strength envelope with linear interpretation and apparent cohesion,  $c'$ ]

### Consolidated-Undrained (CU or R) Test and Consolidated-Undrained (CU' or R-bar) Test with Pore Pressure Measurements

The CU' test is probably the most common triaxial test. With the ready availability of pore pressure measurement devices, the CU test (without pore pressure measurement) is not commonly performed. In the CU and CU' tests, drainage is prevented during back pressure saturation and consolidation, and a saturated soil specimen is consolidated under a specified confining pressure. Similar to the CD test, the CU or CU' test can be performed using either isotropically consolidated (IC-U) samples or anisotropically consolidated (AC-U) samples. IC-U is generally the most common; however, AC-U tests are sometimes selected to model initial shear stress in soils.

After pore water pressures generated by application of the confining pressure are dissipated, the specimen is sheared to failure with a closed drainage valve. Pore water pressures are either not measured during the consolidation shear stage (CU test) to produce total stress strength parameters ( $c$ ,  $\phi$ ) or measured during the consolidation shear stage (CU' test) in which case

both total and effective stress strength parameters ( $c'$ ,  $\phi'$ ) can be obtained.

A backpressure is applied to the pore water to maintain saturation of the soil specimen. Maintaining saturation allows accurate measurement of pore water pressures.

The CU and CU' tests are suitable for both cohesionless soils (sands and gravels) and cohesive soils (clays and silts) and are performed at a faster shear strain rate compared to the CD test. Because both total and effective stress strength parameters can be obtained from a CU' test, CU tests are not often done, as noted above. CU or CU' tests on sands and gravels are usually performed on remolded samples because of the difficulty of obtaining quality, undisturbed samples of cohesionless soils. Refer to Figure 10 for failure envelopes corresponding to CU and CU' tests.

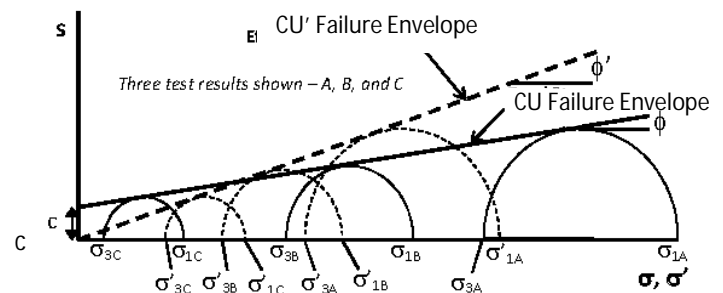

Figure 10: CU and CU' test results.

Examples of when to perform a CU or CU' test include the following conditions: rapid load application to a soil previously consolidated under a smaller load, upstream drawdown of a reservoir and a saturated slowly permeable embankment, and shear strains causing sudden load application to a saturated, consolidated soil mass.

### Direct Simple Shear Test

The direct simple shear (DSS) test is sometimes used when shear strength is expected to exhibit significant anisotropy, such as for some clay soils. The test typically measures the shear strength on the horizontal plane. DSS testing is performed as described in ASTM D6528.

In the DSS test, the volume of a soil specimen is kept constant during shearing to simulate undrained



conditions. The soil specimen is confined by a flexible, cylindrical rubber membrane reinforced with wire or by stacked plates confining the specimen in a standard membrane. The specimen is placed between a base pedestal and top plate, as shown in Figure 11. A vertical load ( $P_v$ ) is applied to the specimen from the top plate, and the soil is sheared by moving the top plate horizontally at a constant rate ( $P_h$ ). The stiff frame of the wire-reinforced membrane or stacked plates provides lateral confinement. The wire-reinforced membrane or stacked plates allow for horizontal displacements along the shear plane during shearing, but maintain a constant specimen height by adjusting the vertical load.

Drainage is prevented through the base pedestal and the top plate, and thus volume change does not occur and pore water pressures are generated in the DSS test. There are some systems that use backpressure and measure pore water pressures, but the most common method is to equate the change in vertical stress required to maintain a constant height with the equivalent pore water pressure that would have developed under undrained conditions.

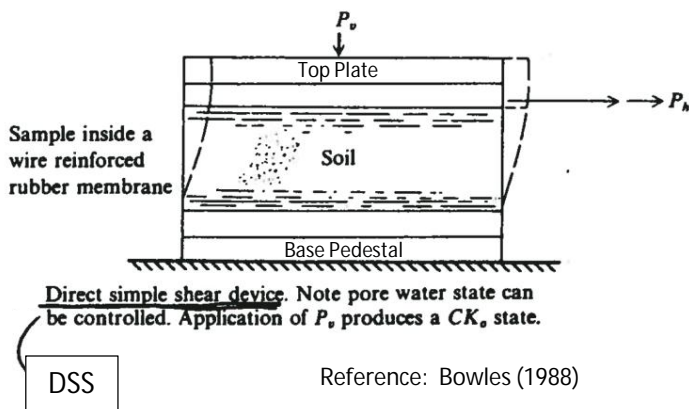

Figure 11: Direct simple shear test apparatus.

The DSS test is most suitable for evaluating the undrained shear strength ( $S_u$ ) of soft cohesive soils (clays and elastic silts). The undrained shear strength is defined as the peak horizontal shear stress achieved during testing.

The DSS test should not be confused with the DS test, which was discussed earlier. The DS test utilizes a shear box with two rigid sections and forces a shear plane to develop between the two. An important difference is that the DS test measures drained shear strength parameters and is not suitable for predicting undrained shear strengths, as discussed earlier. In contrast, the DSS test measures only undrained strengths. The DSS test is not as commonly used as the DS test.

### Torsional Ring Shear Test

The torsional ring shear test is used when investigating the shearing resistance of soils at very large strains or displacements. The test is performed as described in ASTM D6467 and D7608.

In the torsional ring shear test, a remolded soil specimen in the shape of a ring with a rectangular cross-section is confined by an external ring. Porous ceramic plates are placed at the top and bottom of the soil specimen. An effective normal stress ( $\sigma'_n$ ) is applied to the specimen through the top plate, as illustrated in Figure 12. The specimen is sheared by continuously rotating the lower half of the specimen in one direction while the upper half reacts against a torque arm that is held in place by a proving ring or load cell at each end. The torque arm measures the load as the soil specimen is sheared along a horizontal plane that passes through the specimen. The torque applied to the upper porous plate is used to calculate the average shear stress on the failure surface.

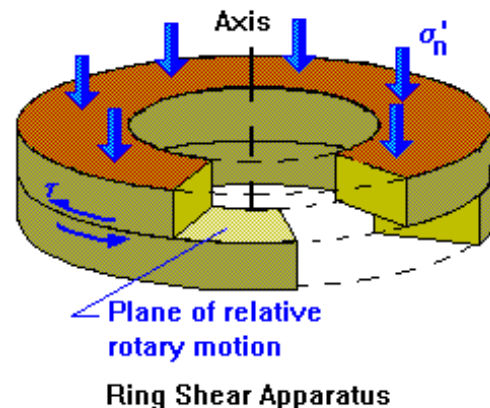

Figure 12: Torsional ring shear test apparatus.

The torsional ring shear test can measure shear stresses over any magnitude of displacement and is therefore suitable for estimating residual shear strength, as shown in Figure 13. The test is primarily used for evaluating the drained residual shear strength of cohesive soils (clays and silts). The specimen must be sheared slowly enough that pore water pressures do not develop. This is generally not a problem because of the small sample height and resulting short drainage path. A minimum of three remolded specimens is generally tested under different normal stresses that are representative of field conditions to evaluate the drained residual failure envelope.

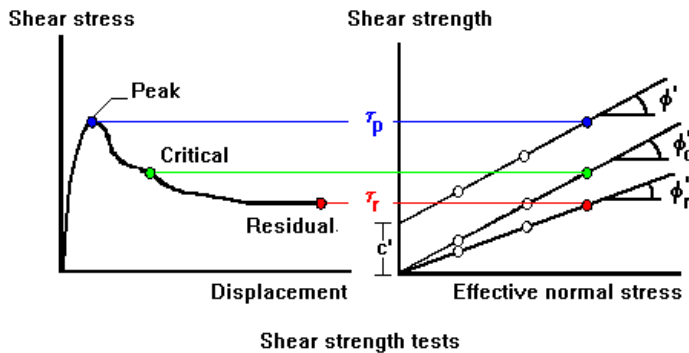

Figure 13: Torsional ring shear test results.

### Laboratory Testing Shear Strength Characterization Summary

The table below presents a summary of the aforementioned laboratory tests and the shear strength characterization evaluated by each test.

Laboratory Test	Shear Strength Characterization
Direct Shear (DS)	Drained effective stress shear strength parameters ( $\phi'$ , $c'$ ) for fine-grained sands, clays, and silts
Unconfined Compression (UC)	Undrained shear strength ( $S_u$ ) for saturated cohesive soils (clays and silts)
Unconsolidated-Undrained Triaxial (UU or Q)	Undrained total stress strength parameters ( $\phi$ , $c$ ) for cohesive soils (clays and silts)
Consolidated-Drained Triaxial (CD or S)	Drained effective stress shear strength parameters ( $\phi'$ , $c'$ ) for cohesionless soils (sands and gravels) and cohesive soils (clays and elastic silts)
Consolidated-Undrained Triaxial (CU or R)	Undrained total stress strength parameters ( $\phi$ , $c$ ) for cohesionless soils (sands and gravels) and cohesive soils (clays and silts)

Laboratory Test	Shear Strength Characterization
Consolidated-Undrained Triaxial with Pore Pressure Measurements (CU')	Undrained total stress strength parameters ( $\phi$ , $c$ ) and drained effective stress strength parameters ( $\phi'$ , $c'$ ) for cohesionless soils (sands and gravels) and cohesive soils (clays and silts)
Direct Simple Shear (DSS)	Undrained shear strength ( $S_u$ ) most suitable for soft cohesive soils (clays and elastic silts)
Rotational Ring Shear	Drained effective stress residual shear strength parameters ( $\phi'_r$ , $c'_r$ ) most suitable for cohesive soils (clays and silts)

### Evaluation of Laboratory Test Data

Engineers should be capable of prescribing and critically reviewing laboratory test data with regard to soil strength characterization. Listed below are the main categories of data that should be critically evaluated:

- Method of sample preparation
- Initial sample data
- Backpressure data (when applicable)
- Consolidation data (when applicable)
- Final water contents
- Stress, strain, and pore pressure data
- Plotted data

### Field Testing for Shear Strength

In-situ testing of embankment or foundation materials for direct shear strength measurements is performed by the following methods:

- Vane Shear Test (ASTM D2573)
- Pocket Penetrometer Test
- Torvane Test

The vane shear test is the most widely used field test for measuring the undrained shear strength of soft to medium stiff clays. In the field vane shear test, a four-bladed vane is pushed into the soil and rotated until the soil fails in shear along a cylindrical surface. The resisting torque is measured to evaluate the undrained shear strength. A schematic of the vane shear test apparatus is shown in Figure 14.

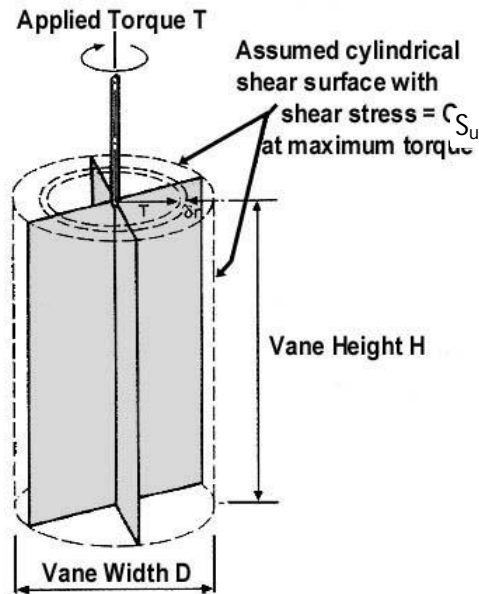

Figure 14: Vane shear test apparatus.

Both the pocket penetrometer and torvane tests are quick field tests which provide approximate measurements of undrained shear strength, subject to appropriate limitations. The pocket penetrometer test provides an approximate measure of the unconfined compressive strength of soils through a small scale bearing capacity test. The piston at the end of a pocket penetrometer, shown in Figure 15, is pressed into the soil to get a measurement of the unconfined compressive strength. It can give misleading results because it only tests a small area of soil and can easily be affected by disturbance.



Figure 15: Pocket penetrometer.

The torvane test provides an approximate measure of undrained shear strength rather than the unconfined

compressive strength; remember that undrained shear strength ( $S_u$ ) is equal to one-half of the unconfined compressive strength ( $q_u$ ). In a torvane test, a soil sample is removed from an area of interest and the vane end of a torvane, shown in Figure 16, is pushed into the soil sample. The torvane is twisted until it breaks free from the sample. The dial gauge is used to measure the shear strength.



Figure 16: Torvane.

Field testing is a crude method of measuring shear strengths in comparison to laboratory testing. Field testing should be used only as an approximate first estimate of undrained shear strength, with the strength estimates further refined by laboratory tests for purposes of analysis and design.

The Standard Penetration Test (SPT), Cone Penetrometer Test (CPT), and shear wave velocity measurements can be used to estimate shear strength parameters through the application of empirical correlations. These methods of investigation are described in numerous geotechnical engineering reference books and will be discussed in the follow-on (Part 3) to this article. Several recommended references are listed at the end of this article.

### Conclusion

Shear strength characterization is a fine art that requires experience and knowledge to assign tests relevant for the soil/sample type and loading conditions needing to be analyzed. Interpreting the results also requires an educated eye to evaluate all pertinent test parameters to determine the confidence level in the results. A subsequent article will discuss utilizing laboratory and field testing results for selection and development of shear strength parameters to be used in analyses.

# Western Dam Engineering

## Technical Note

---

### Useful References

- [1] *Strength of Materials for Embankment Dams*, United States Society on Dams, February 2007.
- [2] *Soil Strength and Slope Stability*, J. Michael Duncan and Stephen G. Wright, 2005.
- [3] *Engineering Field Manual, Chapter 4 - Elementary Soil Engineering*, U.S. Dept of Agriculture, Natural Resources Conservation Service (NRCS), July 1984 (Fourth Printing).
- [4] *Earth Manual, Part 1*, U.S. Department of the Interior, Bureau of Reclamation, 1998 (Third Edition).
- [5] EM 1110-1-1804, Geotechnical Investigations, U.S. Army Corps of Engineers, January 2001.
- [6] EM 1110-1-1802, Geophysical Exploration for Engineering and Environmental Investigations, Department of the Army, U.S. Army Corps of Engineers, 31 August 1995.
- [7] FHWA NHI-06-088, *Soils and Foundations, Reference Manual – Volume 1*, U.S. Department of Transportation, Federal Highway Administration, December 2006.
- [8] *Manual on Estimating Soil Properties for Foundation Design*, EPRI EL-6800, Electric Power Research Institute (EPRI), August 1990.



### How Low Can You Go? The Needs and Considerations for Outlets



Photo 1: Releasing 300 ft<sup>3</sup>/sec through a Low Level Outlet at Dam in Utah

#### Introduction

Whether your dam is a modern wonder of the world or a low-head earthen dam tucked away in a rural community, your dam impacts the environment and populations on both sides of the structure. One of the more routine operations of managing a dam is reservoir drawdown. This article will discuss the reasons for drawing down a reservoir, the methods available for reservoir drawdown, the potential impacts, and other things to consider when drawing down a reservoir. Dam ownership, regulation, and operation vary from the federal government, state government, local municipalities, utility providers, and in some cases private individual or group owners. Because no two dams are the same and their ownership, operations, obligations, and impacts are very specific to their individual circumstances, this article will discuss these topics in generalities.

#### Reasons for Drawdown

Reservoir drawdown simply means the release of water stored behind a dam such that the reservoir water level decreases. The reasons for drawing down a reservoir can vary widely based on the purpose of the dam. Dams are built for a variety of purposes: to develop irrigation supply for agriculture, municipal water supply for populated communities, power generation through use of hydroelectric turbines; to store and attenuate water during times of high

precipitation or snow melt runoff, to develop/restore various types of ecosystems, or combinations of all of these services. Dams also provide recreational opportunities as well as attractive residential property around their reservoirs, although these are generally ancillary benefits and not primary reasons for constructing a dam.

The purposes, schedules, rates, and magnitudes of reservoir drawdowns are generally described in a dam's Operation and Maintenance Manual (O&M) and/or Emergency Action Plan (EAP). Drawdowns can occur for recreation, environmental considerations, water supply agreements, or dam safety concerns. Drawdowns mandated by Dam Safety regulatory agencies can be driven by poor operating conditions or damage of the dam, stability concerns, design issues, maintenance, or repairs. Reasons for reservoir drawdowns are discussed further below.

**Supply** – The stored water behind dams may be released downstream to supply irrigation canals, pump stations, and/or water treatment plants located downstream. Water releases are also sometimes used to maintain specific waterway stages so they may be serviceable to recreational and commercial boating. In the case of routine systematic drawdowns, release schedules are often based on water distribution agreements negotiated between dam owners and water use stakeholders.

**Seasonal Operation** – Reservoir operation is often cyclical based on seasonal weather patterns. Dam operators often drawdown their reservoirs to provide storage space prior to seasons of high precipitation and/or snow melt runoff. The high inflows then refill the reservoir. This is typically followed by a season of low precipitation, which usually coincides with the above-described demands for supplementing downstream water supply and the reservoir is gradually drawn down. And the cycle repeats.

**Flooding** – Normal operating levels for reservoirs are established to provide additional freeboard and storage for infrequent but significant precipitation events. During these events, the increased inflow can be stored, reducing the peak flood discharge downstream. After the flood, the reservoir is lowered at a controlled rate to the normal operating level.

# Western Dam Engineering

## Technical Note

**Sediment Flushing** – A side effect of a dam located along a stream or river (as opposed to an off-channel impoundment in which water is piped to the reservoir) is the accumulation of sediment that would otherwise travel downstream. In addition, the presence of a dam will also significantly lower the natural flow rate and energy through a waterway, allowing sediment to settle to the lake bottom and accumulate adjacent to the dam, rather than stay suspended and be transported downstream. In some cases, dams have scheduled releases designed to flush sediment trapped behind the dam and/or to flush sediment built up in the downstream channel. However, the presence of the sediment can also result in undesirable or unintended release of sediment during drawdowns initiated for other reasons; these can impact the downstream waterway, if not properly controlled. Managing unintended sediment release may include using higher level intakes, controlling the discharge rate, and limiting the drawdown level.

**Environmental/Biological** – Because dams significantly alter the natural flow and water quality conditions of a river/stream, it is often required as part of a dam owner's operation to release water for downstream environmental considerations. These drawdowns are usually governed by regulatory agreements. The releases are designed to benefit the downstream ecology and habitat by maintaining temperature and flow conditions beneficial to the aquatic species, supporting wildlife spawning, eradicating invasive species, and building beaches.

**Inspections, Repairs, & Modifications** –To inspect, repair, or construct modifications to a dam, it may be necessary to lower the reservoir significantly to provide safe access for these activities. If the outlet system is the item in need of repair, a temporary means of drawdown may be required, such as a siphon (see Methods of Drawdown, below).

**Damage/Distress** – A dam or its appurtenant structures can be damaged due to natural events such as an earthquake or extreme flood, a human-induced event such as vandalism or sabotage, or long-term wear and erosion. This damage may be severe enough that the dam is at risk of failure. Under these cases it is critical to be able to lower the reservoir as fast as

safely possible to reduce the loading on the dam and risk of failure.

### Methods for Drawdown

All dams are, or should be, equipped with outlet structures or systems for releasing water. Dams can be outfitted with different combinations of discharge structures with varying degrees of redundancy. For the purposes of this article, overflow spillways will not be discussed, as they are designed to pass flood flows in an uncontrolled manner (i.e., without human or mechanical operation) rather than to lower reservoirs by significant levels in a controlled sequence of operation.

This article focuses on the need and use of mechanical outlet works systems designed to discharge water for the reasons described above. Often these outlet works consist of, from upstream to downstream, an intake structure, control valve/gate system, conveyance conduit, and discharge structure/basin. Different agencies/regulators, both federal and state have guidelines for minimum drawdown capacities of outlet works systems. These regulations often differ between jurisdictions and between hazard classifications. For example, for high hazard dams, the Colorado State Engineer's Office requires that the outlet works system be capable of releasing the top five feet of reservoir capacity within five days.



Photo 2. Outlet Commissioning Test. Photo from the Dam Safety Branch of the Colorado State Engineer's Office.

It is not uncommon to have multiple sets of outlet works systems, where one is set up for routine discharges and another designed to significantly lower

the reservoir. The latter is generally termed a low-level outlet. Low-level outlets are operated when the reservoir needs to be drawn down below the invert of other discharge structures. With a reservoir at normal pool, a low-level outlet system is typically under a much larger magnitude of static and dynamic hydraulic pressures than the other outlet structures on the dam. Ideally, a reservoir would be drawn down using other available outlet structures until the reservoir has reached the lowest achievable elevation before operating the low-level outlet. This will help reduce stress on the system. A low-level outlet system is typically only used to dewater a reservoir for inspection or construction activities or in the case of emergencies. When designing a low-level outlet, predicted sediment accumulation should be considered. If the low-level outlet is buried beneath enough sediment that it cannot release water effectively, dredging will be required to maintain serviceability. A low-level outlet should be equipped with an adjustable control valve or gate, such that water release can be throttled. Since most reservoirs are bowl-shaped, the rate of drawdown will increase at lower levels if the discharge rate remains the same. Having adjustable valves or gates will allow the dam operator to control the reservoir drawdown at constant rates by slowing the release flow as the pool draws down.

For cases where there is no low-level outlet system, or the outlet system is unsafe for use, a siphon can be installed, providing the ability to lower the reservoir. A siphon is generally installed over the dam or spillway, providing a safe and easily constructible, but usually temporary, outlet option for dam owners. A detailed discussion about siphons was presented in [Volume 1: Issue 1 of \*Western Dam Engineering: Technical Notes\*](#).

### Impacts of Drawdown

Dams and the reservoirs they impound have significant impacts on the communities and environments around them. The drawdown of a dam's reservoir is one of the more impactful aspects of dam operation. Reservoir drawdown can have far reaching effects on the environment downstream, upstream, and even the dam itself. The magnitude of these impacts or whether they exist is dependent on the size of the dam, volume of the reservoir, discharge capacity of the dam, and

sensitivity and capacity of the downstream channels. Below is an overview discussion of the different impacts that may occur when drawing down a reservoir.

**Downstream** – The most obvious impacts of drawing down the reservoir are the impacts it has downstream. The downstream channel will experience higher flows and will introduce more energy to the system. This also impacts any basins that the immediate downstream system ties to. Significant reservoir drawdown will impact the performance of downstream drainage and irrigation systems, introducing a much larger volume of water that may exceed their capacity, overwhelm those systems, and result in unintended flooding.

**Environmental** – Downstream flood plain habitats and species can be significantly impacted by large reservoir discharges. Raising the level of the downstream channel can have negative impacts upon vegetation, significantly increasing the flow and velocity within the channel can wash away certain species of wildlife and disrupt migration patterns. In some cases, large reservoir drawdowns can alter the chemical composition of the aquatic environment by changing the PH levels, salinity, or temperatures, rendering the environment unlivable for certain species.

**Sedimentation** – Releasing water from the reservoir will often release sediment accumulated behind the dam. Sediment may be deposited in the downstream channel, reducing the channel capacity and exacerbating downstream flooding. The release of trapped sediment can also significantly increase turbidity in downstream habitats, and can often have detrimental effects on aquatic wildlife. The US Army Corps of Engineers regulates releases from reservoir through their Regulatory Guidance letter 05-04 (USACE, 2005).

**Upstream/Reservoir Rim** – Reducing the reservoir level significantly can also change the upstream habitat, affecting bird nesting and accessibility of water for wildlife.

Some reservoirs used for recreational activity such as boating may become unnavigable, inaccessible, or unsafe. If there are structures such as residential properties, immediately surrounding the reservoir, a



# Western Dam Engineering

## Technical Note

significant reduction in the lake level can expose saturated soils and cause slope and foundation failures.



Photo 3. Residential Boat Dock Left High and Dry by Reservoir Drawdown  
A fairly obvious impact of reservoir drawdown is the loss of the water resource. Drawdowns can leave irrigation intakes "high and dry" and lot of irrigators...irritated.



Photo 4. Irrigation Well Left High and Dry by Reservoir Drawdown  
Increased amounts of debris may be produced from the newly exposed rim, which can begin to clog spillways and trashracks. For large volume releases, the increased energy in the reservoir can transport previously stable sediments in upper reaches of the

reservoir. In select cases, significant reservoir drawdown could expose culturally or historically sensitive areas that were previously submerged.



Photo 5. Reservoir Debris at Intake during a Period of Reservoir Drawdown. Photo by Wyoming State Engineer's Office

**Damage to Dam and Appurtenant Structures –** For earthen embankment dams, rapidly reducing the reservoir level by a significant magnitude can develop excess pore pressures in the upstream slope of the dam, leading to a slope failure in the upstream portion of the embankment. This loading condition is called rapid drawdown. While some maximum drawdowns may be specific to local regulations, many dam experts advocate a maximum 1 foot of reservoir drawdown per day as a rule of thumb. While large volumes of water are discharged through the outlet works system, high energy flows have the potential to damage components of the outlet works system. Particularly for unvented outlet works, cavitation can cause significant damage to the outlet works components and the dam itself. A detailed discussion about venting conduits was presented in [Volume 1: Issue 2 of Western Dam Engineering: Technical Notes](#).



Photo 6. Damage Incurred to Outlet Conduit during Operation



### Considerations

Every dam should have an up-to-date Operations and Maintenance (O&M) manual. The O&M manual should cover all facets of the dam and have detailed guidelines and schedules for releases, if applicable. When developing or updating an O&M, a detailed assessment should be made with respect to all the factors listed in the previous section of this article. This must include a clear understanding of flooding impacts downstream as assessed by the local engineering authority with respect to the varied volumes of water released. The methods for discharging water through the outlet works detailed in the O&M manual should take into account the structural capacity of the outlet structures as well as the capacity of the downstream channels, such that they do not overwhelm the system.

The O&M manual and EAP should have a comprehensive list of stakeholders who are to be notified prior to routine releases as well as unexpected releases. This not only includes parties downstream, but parties located upstream who may be impacted as well. The notifications may have a tiered arrangement dependent on the magnitude of reservoir drawdown expected. For example, small routine releases may have minimal impacts, there may only be a handful of parties to notify. Conversely, if your dam is experiencing an emergency and requires an immediate dewatering of the reservoir, your notifications may include numerous communities upstream and downstream, local jurisdiction officials (Dam Safety Office, Department of Water Resource Management, Department of Environmental Protection, federal and/or local wildlife management officials, etc.) utilities, and emergency services.

Depending on the jurisdiction and the scale of your dam, you may be required to have an Environmental Impact Assessment, which details the effects a major drawdown has on the local wildlife and habitats. Some dams have established protocols to mitigate some of the impacts made by large volume releases.

Inspection of the structural integrity of the dam and its outlet works structures should be a routine occurrence for dam operators. However, if a significant release is anticipated with sufficient lead time, an assessment of

the condition of the outlet works system should be made. It is common and highly recommended that all of the outlet systems be operated fully, or “exercised” on an annual basis. This can provide notice of damage or operating deficiencies that can be remedied before a real emergency occurs. Repairs should be made if possible before the drawdown; however, if this cannot be achieved prior to the release, there should be a modification to the discharge methodology to account for the deficiencies and monitoring of the system’s performance during operation. For high head dams, a major drawdown puts tremendous stress on the dam system, especially for improperly designed outlet systems or systems with inadequate ventilation (See Volume 1: Issue 2). Following a major reservoir drawdown, the dam structure itself and its appurtenant structures should be inspected for damage that may have occurred during the event prior to refilling the reservoir.

### Common Pitfalls in Drawdown Design and Operation

Listed below are possible outcomes of lack of planning, coordination, or infrastructure that can take place when drawing down a reservoir.

- ❖ Releasing water at too high of a rate, causing upstream slope instability and/or damaging outlet works.
- ❖ Inadequate notifications leading to flooding of downstream areas, disruption of water delivery services, or regulatory enforcement actions and/or penalties.
- ❖ Unintended habitat destruction or wildlife casualties.
- ❖ Major alterations of downstream channel conditions, such as scouring or shoaling.
- ❖ Property damage both upstream and downstream.
- ❖ Inability to drawdown reservoir due to lack of low-level outlet or siphon, sedimentation or debris buildup, or improper design of outlet works inverts.
- ❖ Unvented outlet works during high head releases that lead to cavitation in pipes and outlet works structures.

# Western Dam Engineering

## Technical Note

- ❖ Uncontrollable flow during release due to inability to adjust or throttle valves and/or gates because of lack of design or maintenance.

It is a fact of life that dams pose hazards of varying degrees to the populations and environments surrounding them. But with proactive understanding of the capabilities and limitations of our dam systems, identification of the potential impacts around them, and proper coordination, these effects can be mitigated by planning and if necessary, modification. Having an operable system to allow controlled reservoir releases is imperative to the safe operation of dams, both small and large.

### Useful References

- [1] French, Richard. (1984). *Salinity in Watercourses and Reservoirs*. Massachusetts: Butterworth Publishers
- [2] [State of Colorado: Department of Natural Resources. \(2007\). \*Rules and Regulations for Dam Safety and Dam Construction\*](#)
- [3] United States Department of the Army: US Army Corps of Engineers. (1975). *ER-1110-2-50: Low-Level Discharge Facilities for Drawdown of Impoundments*
- [4] [United States Department of the Army: US Army Corps of Engineers. \(2003\). \*EM 1110-2-1902: Slope Stability\*](#)
- [5] [United States Department of the Interior: US Bureau of Reclamation. \(1987\). \*Design of Small Dams\*](#)
- [6] United States Department of the Interior: Bureau of Reclamation. (1990). *Criteria and Guidelines for Evacuating Storage Reservoirs and Sizing Low-Level Outlet Works*
- [7] [United States Department of the Interior: Bureau of Reclamation. \(2011\). \*Appurtenant Structures for Dams \(Spillway and Outlet Works\) Design Standards\*](#)
- [8] US Army Corps of Engineers, Regulatory Guidance Letter 05-04, August 19, 2005, *Guidance on the Discharge of Sediments From or Through a Dam and the Breaching of Dams, for Purposes of Section 404 of the Clean Water Act and Section 10 of the Rivers and Harbors Act of 1899*

### Dam Overtopping Failures – Lessons Learned from the September 2013 Colorado Flood Event

#### Introduction

During the September 2013 flooding in Colorado, nine low hazard dam failures were documented. Forensic investigations for several of these dams identified possible causes of failure. This article shares those possible causes of failure and the lessons learned. It is the intent of this article for engineers and dam owners alike to apply the lessons learned to low hazard dams in an attempt to preserve these vulnerable but valuable structures from failure during events larger than those for which they were designed.

The potential for an earthen embankment dam to survive an overtopping event depends on the condition of the dam at the time of the event, the materials used to construct the embankment, the duration and depth of overtopping, and the duration and intensity of the storm event. Small, low hazard embankment dams are typically designed for rain events with return periods between 25 and 100 years. Unlike high and significant hazard dams, most low hazard dams are not designed to safely pass large, infrequent storms and are therefore susceptible to damage and failure during inflow events greater than a 100-year type of event. Higher hazard dams have more stringent spillway design standards due to the consequences associated with their failures. Although consequences to the downstream public due to failure of low hazard dams are less severe, the value of these structures to their owners can be considerable.

In this article, case histories of dam overtopping failures that occurred during the September 2013 storm event are presented. Each dam's condition and performance during the event are reviewed and lessons learned following these dam failures are discussed.

The dam failures presented in this article include:

- The Upper and Lower Emerald Valley Dams located in the Pikes Peak Region of El Paso County

- A series of five dams on the Little Thompson River in the Big Elk Meadows Subdivision within Larimer and Boulder Counties
- Carriage Hills No. 2 Dam near Estes Park

The lessons learned presented in this article may be old hat for some readers, but it is beneficial for the less experienced dam engineer and owner to understand the sensitivity of dam performance to some of these more common-knowledge issues.

#### September 2013 Storm Event in Colorado

The historic rainfall event that occurred between September 8<sup>th</sup> and 18<sup>th</sup>, 2013 was responsible for extensive flooding along the Colorado Front Range, extending from El Paso County in the south to Larimer County in the north over an area of approximately 11,000 square miles. During this event, several individual storms contributed to the overall precipitation totals; however, a large storm event that occurred on September 12 and ended September 13, 2013 was the most significant contributor to the dam failures, setting a one-day rainfall record for Colorado (Doesken 2014). The September 2013 event was one of the top three extreme storms documented in Colorado (Doesken 2014). The maximum measured rainfall for the September 2013 storm was recorded near the town of Boulder and resulted in 20 inches of precipitation over a 10-day period.

#### Emerald Valley Dams

The Upper and Lower Emerald Valley Dams (UEV and LEV) are located on Little Fountain Creek on U.S. Forest Service property in the Emerald Valley Ranch Resort, about 6.5 miles southeast of the Pikes Peak summit. An aerial image of the dams is shown in Photo 1. Both dams are classified as low hazard.

Due to their small sizes and remote locations, the dams were not previously regulated and no information about the dams was available. The existing condition of the dams was inferred based on conditions observed post-failure and from information obtained as part of the design and reconstruction of these two dams.

# Western Dam Engineering

## Technical Note



Photo 1: Aerial image of UEV and LEV Dams.

Based on post-failure survey data, the UEV Dam was estimated to have a maximum height of 12 feet and storage capacity of approximately 6.4 acre-feet. The LEV Dam was a larger structure, with an estimated maximum height of 14 feet and storage capacity of approximately 11.4 acre-feet.

Post-failure inspections of the UEV Dam identified at least eight pipelines penetrating through the embankment and ranging in diameter from 8 to 30 inches (see Photo 2). The pipe penetrations were the only means for releasing inflows from the reservoir, since the UEV Dam did not have an emergency overflow spillway. Additionally, a septic tank was observed embedded within the left abutment of the embankment with pipelines extending parallel to the dam crest to a leach field on the right abutment. It was also observed that the dam crest elevation was not uniform along the length of the dam and contained several low areas.



Photo 2: UEV Dam post-failure looking upstream.

Similar to the UEV Dam, post-failure inspections of the LEV Dam revealed the dam crest elevation was not uniform along the length of the dam and contained several low areas. Post-failure inspections also indicated the dam was constructed on a timber foundation to support the embankment over organic foundation materials with a timber cutoff wall constructed below the core of the dam. The principal spillway for the LEV Dam was a 3-foot-diameter corrugated metal pipe (CMP) drop inlet located near the left abutment. It is unknown if a trashrack was installed at the inlet to the pipe. An emergency spillway also consisting of a 3-foot-diameter CMP was found near the right abutment. The elevations of the principal and emergency spillways are unknown, but it is likely the emergency spillway was higher in elevation than the principal spillway and would only be active in large floods, such as the September 2013 storm. An 18-inch diameter steel low-level outlet was observed near the central portion of the dam, but it is unknown if the outlet was operational or had a trashrack.

In 1997, the LEV Dam had reportedly failed. The downstream slope in the area of the breach was reconstructed with a relatively steep slope compared to other areas of the downstream slope that were fairly gentle. Aerial photos indicate the 2013 failure occurred at the same location as the 1997 failure. The LEV Dam repairs completed in 1997 may have contributed to the 2013 failure of the dam, considering the relatively steep reconstructed downstream slope in the area of the failure. It is also likely the timber foundation was also not repaired. Photo 3 below shows the LEV Dam post-failure.



Photo 3: LEV Dam post-failure looking upstream.

According to an eyewitness account, the LEV Dam overtopped and failed first, followed by overtopping and failure of the UEV Dam. Hydrologic modeling



# Western Dam Engineering

## Technical Note

completed as part of the failure investigation supports the eyewitness account that the dams overtopped during the storm event. Failure of the dams was primarily attributed to backward headcutting erosion during the overtopping process. Variations in elevation along the crests of both dams concentrated the overtopping flows in low spots, thereby accelerating the headcutting process. The duration and depth of overtopping sustained prior to failure is unknown. During the flood, several attempts were made to remove debris from the spillways at the LEV Dam.

### *Emerald Valley Dams – Lessons Learned and Mitigation Measures*

- Non-uniform dam crest elevations promote concentrated flow in low spots during overtopping, and thus increase erosion due to headcutting. To minimize overtopping erosion and mitigate dam failure, areas where the dam crest is uneven or falls below the design freeboard should be filled and repaired.
- Irregularities (depressions, oversteepened areas, animal burrows, etc.) and obstructions (pipes, debris, and large vegetation) along the upstream and/or downstream slopes generate concentrated and turbulent flows that increase erosion potential and headcutting. To minimize erosion and mitigate failure, it is ideal to have a uniform downstream slope. Locally steepened sections of embankments should be graded uniformly to provide a consistent dam cross section along the entire length of the embankment.
- Multiple pipeline penetrations through the embankment with no filter zones result in backward erosion piping or failure due to pipe deterioration and defects. Debris within these pipes also prevents flood water from discharging, leading to overtopping of the dam. To mitigate failure, outlet works should be maintained so that they operate as intended. If trashracks are associated with these structures, they should be kept free of debris and possibly cleaned as flood events are approaching and/or occurring.
- Vegetation and debris in the spillway prevent flood water from discharging fast enough to prevent overtopping of the dam. To limit dam overtopping and mitigate failure, the spillway should be maintained and kept free of vegetation and debris

so that it can operate as designed. An open channel overflow spillway has less potential for clogging when compared to the “piped” spillways used at the LEV Dam.

- Modifications and repairs that are not performed satisfactorily may contribute to dam failure. Modifications and repairs to existing small dams should be designed by engineers familiar with the state-of-practice for dam engineering and reviewed by appropriate regulatory agencies.

### Dams near Big Elk Meadows

The Big Elk Meadows complex consists of five dams in series, including (listed from upstream to downstream): Sunset Lake Dam, Rainbow Lake Dam, Willow Lake Dam, Mirror Lake Dam, and Meadow Lake Dam. The dams are situated on the West Fork of the Little Thompson River within the Big Elk Meadows Subdivision, located approximately 5 miles upstream of US 36 along Larimer County Road 47. Sunset Lake Dam is located in northwestern Boulder County, whereas the other four dams are located in southwestern Larimer County. An aerial image of the five dams is shown in Photo 4.

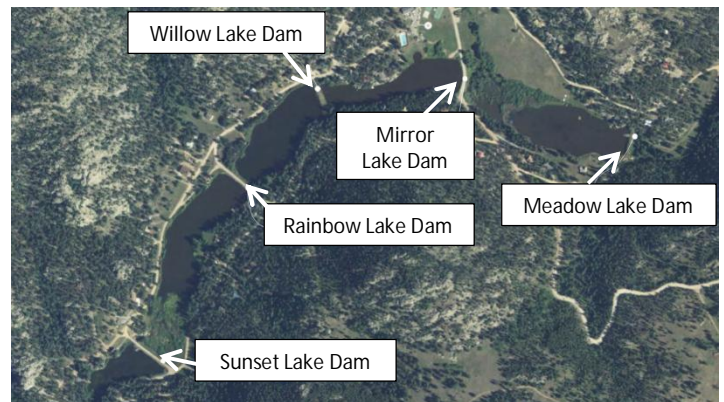

Photo 4: Aerial image of Big Elk Meadows dams.

Meadow Lake Dam is classified as jurisdictional, low hazard. All other dams are classified as non-jurisdictional, low hazard. Since Meadow Lake Dam was classified as jurisdictional, it received regular inspections with the most recent inspection completed in 2008. Limited information was available for the other dams.

# Western Dam Engineering

## Technical Note

Based on available data, Sunset Lake Dam had a maximum height of 6 feet with a maximum storage capacity of 19.3 acre-feet. Rainbow Lake Dam, Willow Lake Dam, and Mirror Lake Dam each had a maximum height of 10 feet with maximum storage capacities of 49.0, 59.6, and 29.9 acre-feet, respectively. Meadow Lake Dam had a maximum height of 10.1 feet with a maximum storage capacity of 90.4 acre-feet. In 2012, the Meadow Lake Dam outlet works was replaced.

A hydrologic study completed for Meadow Lake Dam indicated the spillway was adequate to pass the Inflow Design Flood (IDF) for a minor<sup>1</sup>, low hazard dam (50-year event). A spillway adequacy study was not completed for the other Big Elk Meadows dams; however, documents pertaining to the dams indicate they all had spillway structures that were likely sized to pass the 25-year storm event. The general condition of the dams was thought to be good, Photos 5 and 6 show Sunset Lake Dam after the failure.



Photo 5: Sunset Lake Dam post-failure looking across and downstream from left abutment.

Hydrologic modeling was performed as part of the failure investigation to estimate peak runoff produced by the rainfall. The analyses showed Sunset Lake Dam failed before its rainfall-induced peak discharge. Willow Lake Dam and Rainbow Lake Dam failed approximately 2.5 to 3 hours after their rainfall-induced peak discharges, followed by Meadow Lake Dam, which failed about 4 hours after its peak discharge. Mirror Lake Dam failed about 16 hours after

its peak discharge. The significant volume of inflow in conjunction with the small volume of Sunset Lake likely contributed to the failure of Sunset Lake Dam prior to occurrence of the peak discharge



Photo 6: Downstream slope of Sunset Lake Dam after overtopping looking from left abutment.

The cause of failure for these dams was overtopping, erosion, and formation of a breach. Both Willow Lake Dam and Meadow Lake Dam failed as a result of concentrated flows at low areas in the dam crests near the left abutments. Photos 5 through 10 show each dam after failure.



Photo 7: Rainbow Lake Dam post-failure looking across from left abutment.

<sup>1</sup> Jurisdictional size dam that does not exceed 20 feet in jurisdictional height and/or 100 acre-feet in capacity (CO 2007)



# Western Dam Engineering

## Technical Note



Photo 8: Willow Lake Dam post-failure looking downstream near left abutment.



Photo 9: Mirror Lake Dam post-failure looking downstream from left abutment.



Photo 10: Meadow Lake Dam post-failure looking downstream from within reservoir.

At the time of failure of Willow Lake Dam, Rainbow Lake Dam, Mirror Lake Dam, and Meadow Lake Dam, flood flows were receding, but the dams were still being overtopped. Overtopping durations generally ranged from 7 to 13 hours, with estimated depths up to about 3 feet. The table below summarizes the approximate overtopping durations and depths for each of the dams. The increases in flows due to the

dam failure discharges never approached the peak discharges that had already occurred.

Table 1: Summary of Overtopping Duration and Depth

Dam	Overtopping Duration (hours)	Surveyed Overtopping Depth <sup>1</sup> (ft)
Sunset Lake Dam	7	1.11
Rainbow Lake Dam	12	2.65 (3)
Willow Lake Dam	12	0.24
Mirror Lake Dam	Unknown	3.42 (2)
Meadow Lake Dam	13	1.90

Note: (1) Value in parenthesis is maximum depth reported by eyewitnesses.

The September 2013 storm was not the first extreme flood event on the Little Thompson River watershed. The “Big Elk Meadows Storm” occurred in May of 1969, establishing the highest recorded peak discharge on the Little Thompson River. There were no reports of dam failures during the 1969 storm. While both the 1969 and 2013 storms had similar magnitudes of rainfall, the damaging flows of the 2013 storm are attributed to the duration of the rainfall. In the 1969 storm, rain fell steadily over a 3-day period, whereas in the 2013 storm the majority of rain fell during a 12- to 18-hour period. The Little Thompson River could not sustain the rapid rate of rainfall runoff due to the more intense, shorter duration 2013 storm, thus resulting in a higher rainfall-induced peak discharge and more damaging flows.

### *Big Elk Meadows Dams – Lessons Learned and Mitigation Measures*

- Concentrated flows develop at low spots along a dam crest during overtopping, which increases erosion. Both Willow Lake Dam and Meadow Lake dam failed near the left abutment, where their crest elevations were lower. To minimize overtopping erosion and mitigate dam failure, areas where the dam crest is uneven or falls below the design freeboard should be filled and repaired.
- Well maintained, low hazard embankment dams with uniform crest elevations and good vegetation cover (Photo 6) can survive overtopping durations in excess of 7 hours with depths up to 3 feet. Dam breach (i.e., dam failure) does not always occur immediately following dam overtopping. It is commonly assumed that dam overtopping is



# Western Dam Engineering

## Technical Note

equivalent to dam failure; however, this is not necessarily true. Dams may overtop in the event of a flood, but failure occurs only when overtopping forms a dam breach.

- The duration of rainfall during a storm event impacts the severity of damaging flows. Longer duration, lower intensity storms have a slower rate of rainfall runoff within the watershed, allowing for more infiltration and lower peak discharges. Shorter duration, more intense storms have a more rapid rate of rainfall runoff, leading to higher peak discharges and more damaging flows.

### Carriage Hills No. 2 Dam

Carriage Hills No. 1 and No. 2 Dams (CH1 and CH2) are located in a residential development about 2.25 miles southeast of downtown Estes Park. CH1 Dam is located just upstream of CH2 Dam. An aerial image of the two dams is shown in Photo 11. Both dams are classified as low hazard.



Photo 11: Aerial image of CH1 and CH2 Dams.

Both dams were overtopped during the September 2013 event. CH1 Dam survived the overtopping event with some erosion damage, while CH2 Dam failed.

There is little information available for CH1 Dam. CH2 Dam was designed as a zoned earthen embankment dam with 2H:1V (horizontal to vertical) upstream and downstream slopes, a height of approximately 20 feet, and crest width of 10 feet. Both dams have/had a low-level CMP outlet conduit and uncontrolled overflow spillway. There is no information available pertaining to the size and capacity of the outlet works and spillway at CH1 Dam. At CH2 Dam, the outlet works consisted of a 24-inch-diameter, 12 gauge CMP with an upstream slide gate and reported capacity of 35 cubic feet per second (cfs). The spillway at CH2 Dam was designed to have a 10-foot bottom width, 5 feet of

freeboard below the dam crest, and capacity of 377 cfs.

Inspection reports for CH2 Dam dated 1983, 1985, 1986, 1991, 2002, and 2008 describe conditions with trees and brush growing on the dam and obstructing spillway flow. In 2008, the spillway was reportedly rehabilitated; however, it was not restored to the design size and capacity.

Results from a post-failure survey indicated the CH2 dam and spillway were actually smaller in size than designed. The dam had a height of approximately 10 feet and crest width of 6.5 feet. The spillway had a 4-foot bottom width, 3.4 feet of freeboard, and a capacity of 213 cfs during the time of the September 2013 flood. The maximum storage capacity was not reported, but was estimated for CH2 Dam to be 12.7 acre-feet at the dam crest based on post-failure analyses.

Prior to failure of CH2 Dam, the dam crest was overgrown with trees and shrubs, which can be seen in Photo 12. The spillway was also overgrown with shrubs and small willow trees, as shown in Photo 13. Previous inspection reports noted low areas along the dam crest, specifically in the area of the outlet works conduit.



Photo 12: CH2 Dam post-failure looking downstream from reservoir. Note heavy vegetation on dam crest.

# Western Dam Engineering

## Technical Note



Photo 13: CH2 Dam spillway looking downstream. Note heavy vegetation in spillway.

The overtopping of CH2 resulted in a breach of the embankment, whereas CH1 survived the overtopping event with some scour erosion on the downstream slope, primarily around trees. Overtopping durations and depths are not known. However, significant overtopping of CH1 Dam and at least minor overtopping of CH2 Dam was observed, as shown in Photos 14 and 15. The larger overtopping depth of CH1 Dam was attributed to the smaller spillway capacity at CH1 Dam compared to CH2 Dam, based on visual inspection and an overgrowth of small willows in the spillway. During the flood, the willows matted together, forming a 2-foot-wide notch through which flow was concentrated (see Photo 16).



Photo 14: CH1 Dam overtopping.



Photo 15: CH2 Dam overtopping.



Photo 16: 2-foot-wide notch formed in CH1 Dam spillway.

A post-flood survey indicated the dam crest at CH1 was relatively level and the embankment was observed to have a well-maintained vegetation cover. This allowed for overtopping flows to be distributed relatively evenly along the embankment, thus contributing to the dam's survival.

Conversely, based on the post-flood survey it appeared that CH2 Dam failed due to concentrated flow over a low area on the dam crest. Headcutting damage was observed at the downstream slope of the right abutment and to the left of the dam breach. Existing vegetation and debris that had collected in the spillway may have partially restricted flood flow and resulted in greater overtopping flows over the embankment. The inadequate capacity of the spillway at CH2 Dam likely also resulted in greater overtopping flows. The reservoir inflow was estimated to be between 237 and 508 cfs compared to the spillway capacity, which was estimated to be 212 cfs at the time of flooding. It is possible that had the spillway been cleared of vegetation with a backhoe before or during the flood, the spillway may have passed enough flow to allow the

# Western Dam Engineering

## Technical Note

dam to not overtop or to overtop with sufficiently less flow depth and duration to avoid the breach.

### *Carriage Hills No. 2 Dam - Lessons Learned and Mitigation Measures*

- Non-uniform dam crest elevations promote concentrated flow in low spots during overtopping, and thus increase erosion due to headcutting. To minimize overtopping erosion and mitigate dam failure, areas where the dam crest is uneven or falls below the design freeboard should be filled and repaired.
- Large or wooded vegetation, such as trees, bushes, or shrubs do little to protect the dam during overtopping events, but rather develop concentrated flow areas and accelerate headcutting. To minimize headcutting and mitigate failure, vegetation on the downstream slope should be restricted to well-maintained grasses.
- Vegetation and debris in the spillway prevent flood water from discharging fast enough to prevent overtopping of the dam. To limit dam overtopping and mitigate failure, the spillway should be maintained and kept free of vegetation and debris so that it can operate as designed. Emergency Action Plans that include procedures for clearing the spillway and/or sandbagging the dam crest in the event of a large storm could help save the dam in some overtopping situations.
- Spillways that are not constructed as designed can be inadequate in passing flows during larger storm events and result in dam overtopping. To mitigate failure, the spillway should be maintained according to the original design.

### Parting Thoughts

Although it may seem like a no-brainer that these adverse conditions may cause adverse performance of your dam, these conditions are frequently observed during dam inspections. This indicates either a lack of understanding of their importance, or a lack of understanding of the proactive stewardship that comes with being the responsible owner or designer of a dam.

### References

- [1] State of Colorado (CO), *Rules and Regulations for Dam Safety and Dam Construction*, January 1, 2007.
- [2] Hydrometeorological Design Studies Center National Weather Service, National Oceanic and Atmospheric Administration, *Exceedance Probability Analysis for the Colorado Flood Event, 9 -16 September 2013*, 1325 East-West Highway, Silver Spring, MD 20910, 17 September 2013.
- [3] Doesken, Nolan, 2014, *Risk and Response*, Presentation at 2013 Colorado Flood Forum, February 27, 2014, CASFM Conference, Broomfield, CO.
- [4] FEMA 473, 2005, *Technical Manual for Dam Owners: Impacts of Animals on Earthen Dams*, Federal Emergency Management Agency, September.
- [5] FEMA 534, 2005 *Technical Manual for Dam Owners: Impacts of Plants on Earthen Dams*, Federal Emergency Management Agency, September.
- [6] FEMA P-1015, 2014, *Technical Manual: Overtopping Protection for Dams*, Federal Emergency Management Agency, May.