

# STATE OF MONTANA - TIMBER SALE CONTRACT FOR STUMPAGE SOLD BY THE TON

VERSION 18 – JANUARY 2018

<b>DEPARTMENT OF NATURAL RESOURCES &amp; CONSERVATION</b> 2705 Spurgin Road Missoula, MT 59804	<b>NAME, ADDRESS AND PHONE NUMBER OF PURCHASER:</b>	
	Tax I.D. Number	
<b>LAND OFFICE</b> Central Land Office	<b>SALE NAME</b> Blacktail Again	<b>SALE NUMBER</b>
<b>UNIT OFFICE</b> Dillon Unit	<b>AWARD DATE</b>	<b>TERMINATION DATE</b> October 31, 2028

THIS CONTRACT IS MADE AND ENTERED INTO by and between the State of Montana, acting through its Department of Natural Resources & Conservation, Trust Land Management Division (hereinafter called the State) and ( , a sole proprietorship; or , a partnership; or , Inc. a corporation) (hereinafter called Purchaser) having an office and principal place of business at the address shown above. Purchaser's bid on the timber described in this contract has been accepted by the State after having been estimated, appraised and advertised for sale as required by law. Therefore, in consideration of the mutual promises contained in this agreement, the State agrees to sell and the Purchaser agrees to purchase the designated timber located on the areas described in this Contract at the specified rates of payment and in strict conformity with the requirements, standards, specifications and conditions set forth in this Contract.

-CONTENTS OF CONTRACT-			
Section	Page	Section	Page
	2	IV. CONTRACT VIOLATIONS AND	11
I. GENERAL TERMS	3	PENALTIES	
II. CHARGES AND PAYMENTS	9	V. FIRE PROTECTION	14
III. MEASUREMENT AND LOG	10	VI. RESOURCE PROTECTION	15
ACCOUNTABILITY		VII. LOGGING	17
		VIII. EXECUTION	28
-ATTACHMENTS-			
The following attachments are hereby made a part of this contract:			
ATTACHMENT A: Timber Sale Maps			3 Pages
ATTACHMENT B: Road Construction, Improvements and Maintenance Specifications			28 Pages
ATTACHMENT C: Forest Fire Regulations			2 Pages
ATTACHMENT D: Working in Bear Habitat Brochure			1 Page
ATTACHMENT F: Montana Streamside Protection Act (124 Permit)			4 Pages
ATTACHMENT G: Designation by Description			1 Pages

TIMBER SALE CONTRACT

<b>TABLE 1 - LEGAL DESCRIPTION OF THE GROSS SALE AREA</b>			
The timber designated for sale under this Contract is within the following sale area			
<b>Subdivisions</b>	<b>Section</b>	<b>Tw</b>	<b>Rge</b>
Pts. SWSW, SESW	11	12S	6W
Pts. NWNW, NENW, SWNW, SENW	14	12S	6W
Pts. SW1/4, SWSE, SESE, SWSE	15	12S	6W
Pts. NWNE, NENE, NENW	22	12S	6W
Pts. NENW, SENW, NWNE, NESE, SESE	23	12S	6W
Pts. SWNW, NWSW, NESW, SWSW, SESW, NWSE, SESE, SWSE	24	12S	6W
Total approximate acres in gross sale area:	3,840		
Number of harvest units (Including Right-of-Way):	10		
Total acres in harvest units (Including Right-of-Way):	350		

<b>TABLE 1 (continued) - ESTIMATED SALE VOLUME</b>	
The state does not guarantee the product weight, by species or in total, to equal the estimated advertised weight in quantity or product designation.	
<b>Product</b>	<b>Estimated Quantity (Tons)</b>
<b>Sawlogs</b>	14,094 (1.719 MMBF)
<b>Other Material (Firewood, Optional)</b>	1,574
<b>Total Estimated Volume</b>	14,094 (1.719 MMBF)

<b>TABLE 1 (continued) - PAYMENT RATES</b>			
<b>Payment</b>	<b>Amount</b>		<b>Requirements</b>
Performance Bond Amount:	20% of bid value		See Section II.A.1-3.
	<b>Product</b>	<b>Amount</b>	
Stumpage Rate:	<b>Sawlogs</b>	<b>Bid Rate per ton</b>	See Section II.B.1-3.
	<b>Firewood</b>	\$100.00 per load	
Forest Improvement (FI) Fee Per ton:	<b>Sawlogs</b>	\$1.00	See Section II.B.4. Concurrent with Stumpage

## I. GENERAL TERMS

**A. DEFINITION OF CONTRACT LANGUAGE:** The following definitions apply to terms used in this Contract:

1. Administrator – The Forest Management Bureau Chief, Trust Land Management Division, Department of Natural Resources & Conservation
2. Board – The Montana Board of Land Commissioners.
3. Department – The Department of Natural Resources and Conservation.
4. Draw – A swale or drainageway that may not have perceptible or definite beds or banks.
5. Environmental Law – Includes, but is not limited to, the following laws and any regulations promulgated under these laws: the Comprehensive Environmental Response, Compensation and Liability Act (“CERCLA”) (42 U.S.C. § 9601 *et seq.*), as amended; the Resource Conservation and Recovery Act (“RCRA”) (42 U.S.C. §§ 6901 – 6987), as amended; the Clean Air Act (42 U.S.C. § 7401, *et seq.*), as amended; the Safe Drinking Water Act (42 U.S.C. § 300f *et seq.*), as amended; the Clean Water Act (33 U.S.C. § 1401 *et seq.*), as amended; the Clean Air Act of Montana (Mont. Code Ann. § 75-2-101 *et seq.*), as amended; the Montana Water Quality Act (Mont. Code Ann. § 75-5-101 *et seq.*), as amended; the Montana Solid Waste Management Act (Mont. Code Ann. § 75-10-201 *et seq.*), as amended; the Montana Hazardous Waste Act (Mont. Code Ann. § 75-10-401 *et seq.*), as amended; the Montana Comprehensive Environmental Cleanup and Responsibility Act (Mont. Code Ann. § 75-10-701 *et seq.*) as amended; and the Montana Underground Storage Tank Act (Mont. Code Ann. § 75-11-501 *et seq.*) as amended.
6. Forest Officer – The State field representative assigned the job of contract administration for this timber sale Contract. Except as otherwise expressly stated in the Contract, the Forest Officer is not authorized to modify the Contract on behalf of the State.
7. Hazardous or deleterious substance – Means a substance that, because of its quantity, concentration, or physical, chemical, or infectious characteristics, may pose an imminent and substantial threat to public health, safety, or welfare or the environment, and is:
  - a. A substance that is defined as a hazardous substance by section 101(14) of CERCLA, 42 U.S.C. § 9601(14), as amended.
  - b. A substance identified by the administrator of the United States Environmental Protection Agency as a hazardous substance pursuant to section 102 of CERCLA, 42 U.S.C. § 9602, as amended.
  - c. A substance that is defined as a hazardous waste pursuant to section 1004(5) of RCRA, 42 U.S.C. § 6903(5), as amended, including a substance listed or identified in 40 CFR 261.
  - d. Any petroleum product.
8. Operating period – The annual time period during which field activities (logging, hauling, construction, etc.) may be conducted.
9. Paid or payment – Except as otherwise expressly stated in the Contract, full remuneration by either cash, money order or certified check.
10. Purchaser – The signatory party to this Contract other than the Administrator. Purchaser is also defined to include employees and agents of the Purchaser authorized to conduct activities as required for execution of the timber sale Contract. As an independent contractor, neither the

## TIMBER SALE CONTRACT

Purchaser, its employees or agents are considered employees of the State of Montana pursuant to work performed under this Contract.

11. Sawlog – A green or dead log as further defined under Section VII.C.
12. State – The State of Montana and its agents and employees.
13. Stream – A stream is a natural watercourse of perceptible extent that has a sandy or rocky bottom or definite banks and confines and conducts continuously or intermittently flowing water.
14. Stumpage – The rate paid in dollars per ton as specified in Table 1 for Sawlogs and/or Other Material.
15. Supervisor – A person designated by the Purchaser in charge of operations on site at the sale area at all times when construction or harvesting operations are in progress. The Supervisor has authorization to receive notices from the Forest Officer and take appropriate action with regard to breach and/or violations of the terms of the contract.

### **B. REMOVAL OF TIMBER AND TITLE TRANSFER:**

1. Provided the Purchaser has paid for timber as required in Section II.B.1, ADVANCE STUMPAGE PAYMENT, the Purchaser has the right to cut and remove timber from the sale area provided all Contract requirements related to the commencement of operations have been met.
2. Title to all timber included in this contract shall be retained by the State until:
  - a. The timber has been paid for.
  - b. The timber has been measured, as described in Section III.A. MEASUREMENT AND LOG ACCOUNTABILITY.
  - c. The timber has been properly marked and ticketed as described in Section III.C & E. MEASUREMENT AND LOG ACCOUNTABILITY, and removed from the gross sale area,
3. Title to timber remaining on the gross sale area at termination of the contract shall remain with the State of Montana.
4. As documented in this contract, or otherwise agreed to, all roads and other improvements become the property of the State as they are constructed.

**C. TERM OF CONTRACT:** This Contract is effective upon approval and execution by the Administrator and shall terminate on the Termination Date shown on page 1 unless terminated sooner for successful completion or for gross or persistent breach and/or failure to promptly and properly remedy contract violations of the Contract terms pursuant to Section IV. B, TERMINATION.

**D. PRE-OPERATIONS MEETING:** No activity may occur on the sale area until a pre-operations meeting is conducted between the Purchaser and the State. The Purchaser shall notify the Forest Officer at least seven (7) days prior to the start of operations to schedule the pre-operations meeting. The Forest Officer will specify to the Purchaser what information the Purchaser must provide to the State at the pre-operations meeting.

**E. ANNUAL OPERATING PLAN:** Purchaser may be required to submit a written annual operating plan, as specified by, and at the request of the Forest Officer.

### **F. CONTRACT TERM EXTENSION:**

1. In the event that Purchaser's operations are delayed and Purchaser is not able to complete the requirements of this Contract prior to the termination date, the State may grant an extension of

## TIMBER SALE CONTRACT

the term of this Contract. An extension will be considered by the State under only the following circumstances:

- a. The State determines an extension is in its best interests;
  - b. Purchaser applies for the extension in writing at least 30 days prior to the termination date.
  - c. The State notifies the Purchaser that an extension is required.
  - d. Purchaser has provided the State with written notice from the surety that the performance bond on this contract has been extended for a period commensurate with the requested contract extension.
  - e. Purchaser has made a good faith effort to complete the sale.
  - f. The extension request is not based on poor log and/or market conditions.
2. If the contract term extension is granted, Purchaser shall conduct continuous operations through the operating periods and/or resume operations at the start of the next operating period until the requirements of this Contract are completed. No extension shall be granted for a period longer than eighteen (18) months after the termination date as provided herein unless a longer extension is determined to be in the State's best interest.
  3. If the extension is requested and granted because of delays resulting from matters within Purchaser's control, the following will apply:
    - a. Purchaser shall pay an extension fee of \$ 500.00.
    - b. Stumpage rates for any volume cut, skidded or hauled during the extension period will be escalated a minimum of 10% to reflect the interest lost to the trust beneficiaries.
    - c. No de-escalation will occur from the time the extension is granted by the Administrator, as documented in a signed modification, through the remainder of the Contract.
  4. An extension may be granted to the Purchaser without penalty if the State prohibits logging activity for more than 2 weeks during the operating period described in this Contract.
  5. All conditions of this contract shall remain in force during any period of extension, unless those conditions are amended by the terms of the extension.
  6. In the event the Contract terminates pursuant to Section I.C, TERM OF CONTRACT due to expiration of the time within which its performance shall have been completed, and the Department has not granted an extension, the Purchaser shall immediately cease all operations within the Gross Sale Area as shown in Table 1. Operations beyond the contract termination date for which the Department has not granted an extension will be treated as trespass.
- G. LIABILITY FOR LOSS:** The Purchaser is responsible for loss, degradation, or damage to timber while the timber is in his, her or its custody, including but not limited to, timber which has been felled, skidded or decked and/or timber which has been lost, damaged or stolen after removal from the sale area but before scaling or weight is recorded.
- H. SUPERVISION:** When construction or harvesting operations are in progress, the Purchaser shall have exclusive control over the way the Contract is executed if, as determined by the Department, the Purchaser has and is complying with all terms and conditions provided herein. Purchaser is required to have a supervisor(s) in charge of operations on the sale area at all times. Such supervisor(s) shall have authorization to receive notices from the Forest Officer and take appropriate action with regard to breach and/or violations of the terms and conditions of the Contract.

## TIMBER SALE CONTRACT

### **I. COMPLAINTS:**

1. Complaints by the Purchaser concerning any action or decision of a Forest Officer, including suspension orders, must be made in writing to the Administrator postmarked within 30 days of the disputed action or decision. In the interim, Purchaser must comply with the directions of the Forest Officer.
2. Upon receipt of a complaint, the Administrator, or a designated representative, shall promptly hold an informal conference with the Purchaser and the Forest Officer to review the disputed action. The Purchaser shall be given adequate notice of the conference and shall be given the opportunity to present evidence and an argument to rebut the reasons given by the Forest Officer for the disputed action. After review, the Administrator shall notify the Purchaser in writing of his decision. The decision of the Administrator is final on behalf of the State, except regarding termination of the contract.

**J. ASSIGNMENT:** This contract shall not be assigned in whole or in part unless approved in writing by the Administrator.

### **K. MODIFICATIONS:**

1. This contract, together with the attachments listed herein, contains the entire agreement of the parties and no statements, promises or inducements made by either party, or agents of either party, that are not contained in such written Contract shall be valid or binding. This Contract, except as described in Section I.K.2 below, cannot be enlarged, modified or altered except upon written agreement signed by all parties to this contract. Only the Administrator, his successor, his designated representative, or the Board of Land Commissioners, is authorized to enter into such modification on behalf of the State.
2. To protect cultural or natural resources the State may modify provisions of the Contract without prior agreement by the Purchaser. If such modifications occur the State will provide equitable compensation to the Purchaser for those modifications.

**L. EQUAL EMPLOYMENT OPPORTUNITY:** Pursuant to Section 49-3-207, MCA, any hiring by the Purchaser under this agreement must be based on merit and qualifications and there must be no discrimination based on race, color, religion, creed, political ideas, sex, age, marital status, physical or mental disability, or national origin by any person performing this Contract.

### **M. LIABILITY INSURANCE:**

1. Prior to the execution of this Contract, the Purchaser or their agents shall obtain, carry and keep in good standing for the remainder of the contract period, with any extensions:
  - a. Comprehensive general liability insurance coverage to the limit of \$1,000,000.00 per occurrence and \$2,000,000.00 per aggregate. Each such policy shall include endorsements, which shall name the State as an additional insured and shall provide that the State shall be given 30 days' written notice, at the address stated above, prior to cancellation or any material change in such policy.
  - b. Automobile Liability Insurance: The Purchaser shall purchase and maintain coverage with split limits of \$500,000 per person (personal injury), \$1,000,000 per accident occurrence (personal injury), and \$100,000 per accident occurrence (property damage), OR combined single limits of \$1,000,000 per occurrence to cover such claims as may be caused by any act, omission, or negligence of the contractor or its officers, agents, representatives, assigns, or subcontractors.
2. In lieu of such coverage, the Purchaser may provide proof of self-insurance in at least an amount equal to that provided above.

## TIMBER SALE CONTRACT

3. Prior to the commencement of any work to be performed under this contract, Purchaser shall deliver to the State a certificate of insurance from the insurer(s) of the Purchaser or their agents certifying that coverage in at least the amounts stated above is in force. Such certificate shall be submitted to the State for approval of the insurer(s), the amount, and the form. The State reserves the right to require a certified copy of any such policy or to examine the policy itself.
4. A self-insured Purchaser shall provide an equivalent certificate of insurance subject to the approval of the State.
5. It is further understood and agreed that this Contract shall terminate immediately in the event that the mandatory liability insurance coverage required under this part is for any reason not obtained or is discontinued.

### **N. WORKERS' COMPENSATION INSURANCE:**

1. Prior to the commencement of any work under this Contract, Purchaser shall provide written verification to the Administrator that all individuals who are to be engaged in work under this Contract, including but not limited to employees, agents or independent contractors of the Purchaser or of its subcontractors, are either insured for workers' compensation coverage or are exempted from such coverage as certified independent contractors pursuant to § 39-71-401 MCA.
2. It is expressly understood and agreed that no such individual may engage in work in furtherance of this Contract at any time during its period unless either insured for workers' compensation coverage or exempted from such coverage as indicated above.
3. It is understood and agreed that this Contract shall terminate immediately if workers' compensation coverage or exemptions required under this part is discontinued for any individuals engaged in work under this Contract.

**O. SAFETY:** The Purchaser, employees, subcontractors and their employees shall conduct their activities in a safe and workmanlike manner, shall cooperate in making it possible for the Forest Officer to safely, efficiently, and economically perform his, her or its administrative duties, and shall comply with federal and State safety standards for logging operations as established by the United States Department of Labor, Occupational Safety and Health Administration (OSHA; 29 Code of Federal Regulations 1910 and any other such applicable regulations promulgated by OSHA) and as required by Title 50, Chapter 71 of the Montana Code Annotated, and any regulations promulgated to implement the statutes found in that Title and Chapter of the Montana Code Annotated. The Purchaser, and not the State, is responsible for instituting and maintaining all precautions, procedures and programs for the safety of all persons on the project site, and the State hereby disclaims any and all responsibility for injuries or accidents occurring at the site.

**P. SAWMILLS PROHIBITED:** No sawmills shall be allowed to operate on the gross sale area.

**Q. LOG CHIPPERS OR GRINDERS:** No log chippers or grinders shall be allowed to operate on the gross sale area unless written approval to do so is granted by the Forest Officer. In order for approval to be granted, the Purchaser shall identify a method acceptable to the State for the measurement of all wood to be ground or chipped. If the Purchaser intends to operate a log chipper outside of the gross sale area, provisions must be made for obtaining certified weights of either the material removed from the sale or of the resultant products.

### **R. SALE DELAYED OR PRECLUDED BY JUDICIAL ACTION OR GOVERNMENT REGULATORY ACTION:**

1. In the event judicial action, change in applicable law, or implementation of government regulatory action renders proceeding with this contract unlawful, the State will suspend or terminate the Contract in whole or in part. Upon notice of such suspension or termination, Purchaser shall

## TIMBER SALE CONTRACT

immediately cease all or any portion of such operations under the Contract as directed by the State. If a court of competent jurisdiction has entered a final judgment rendering further proceeding with this Contract unlawful, or government regulatory action takes effect, the State may terminate the Contract or, at the State's option, suspend the Contract in whole or in part, pending appeal of the court's final judgment. If the Contract is suspended, the State shall not be liable to the Purchaser for damages or losses resulting from the delay. In the event the Contract is terminated due to judicial action, a change in law, or government regulations, the State shall be liable to Purchaser only as follows:

- a. The State shall refund any portion of advance stumpage payments or down payments not needed to compensate the State for timber removed.
  - b. The State shall release any portion of the performance bond not needed to compensate the State for timber removed or other losses suffered by the State due to breach of contract by the Purchaser.
  - c. The State shall reimburse the Purchaser for the portion of reasonable costs of constructing or improving roads or of installing other facilities on State lands pursuant to this Contract that the Purchaser has not been able to use for removing timber. The Purchaser shall provide documentation requested by the State of the Purchaser's actual costs of constructing or improving such roads or installing other improvements.
- S. VENUE AND CHOICE OF LAW:** In the event of litigation concerning this agreement, venue shall be in the First Judicial District, Lewis and Clark County, Montana, and this agreement shall be governed by the laws of the State of Montana both as to interpretation and performance.
- T. AUTHORIZATION TO ENTER:** The Purchaser is authorized to enter the sale area only for purposes related to the performance of this Contract.
- U. USE BY OTHERS:** The State reserves the right to issue timber permits or other permits on the sale area for forest products not included in this Contract or for other uses not in conflict with this Contract. The State also reserves the right to permit other persons to cross the sale area to gain access to other lands for fire suppression or for other purposes. Where the Purchaser improves or reconstructs an existing road, the use thereafter by the Purchaser shall accommodate safe use by others.
- V. OTHER OPERATIONS BY THE STATE:** The State reserves the right to at any time conduct within the gross sale area forest management operations including, but not limited to, slash piling, burning, handwork, broadcast burning, mop-up, patrolling, thinning and tree planting during the term of this Contract.
- W. INDEMNITY AND LIABILITY:**
1. The Purchaser agrees to indemnify the State, its officials, agents, and employees, while acting within the scope of their duties and hold the State harmless from and against all claims, demands, and causes of action of any kind or character, including the cost of defense, arising in favor of the Purchaser's employees or third parties on account of bodily or personal injuries, death or damage to property arising out of services performed, goods or rights to intellectual property provided or omissions of services or in any way resulting from the acts or omission of the Purchaser and/or its agents, employees, subcontractors or its representatives while engaged in work under this Contract, all to the extent of the Purchaser's negligence.
  2. The Purchaser shall be responsible for, indemnify, defend and hold the State harmless from and against any loss, cost (including, without limitation, reasonable legal, accounting, consulting, engineering and similar expenses), damage, claim, fine or liability, including the necessity for tests, inspections or other work, and any damage, claim, fine or liability arising as a result of such tests, inspections or other work, the State must perform:



## TIMBER SALE CONTRACT

- a. Based upon an actual or alleged violation by the Purchaser of, or failure by the Purchaser to comply with, any Environmental Law during the term of this Contract;
  - b. Arising from the discharge, release, threatened release, handling, storage, treatment, deposit or disposal of any Hazardous or Deleterious Substances caused or exacerbated by the activities of the Purchaser on or in the gross sale area during the term of this Contract; or
  - c. Otherwise arising out of or in connection with any environmental condition or action caused or created by the Purchaser.
- X. OTHER LAWS AND REGULATIONS:** This Contract is subject to all applicable federal, state, county, and municipal laws, ordinances, and regulations in effect at the date of this Contract or which may, from time to time, be adopted, and which do not impair the obligations of this Contract and which do not deprive the Purchaser of an existing property right recognized by law. A violation by the Purchaser of any federal, state, county, and/or municipal laws, ordinances and/or regulations while conducting operations under the terms of this Contract, shall, in the discretion of the State, constitute sufficient reason for the suspension or termination of this Contract. If any part of the lands or premises under this Contract are used or allowed or permitted to be used for any purpose contrary to the laws of this state or the United States, such unlawful use shall, in the discretion of the State, constitute sufficient reason for the suspension or termination of this Contract.
- Y. FORCE MAJEURE:** Neither party shall be responsible for failure to fulfill its obligations due to causes beyond its reasonable control, including without limitation, acts or omissions of government or military authority, acts of God, materials shortages, transportation delays, fires, floods, labor disturbances, riots, wars, terrorist acts, or any other causes, directly or indirectly beyond the reasonable control of the nonperforming party, so long as such party is using its best efforts to remedy such failure or delays. Force majeure will not relieve the Purchaser from liability for damage or otherwise excuse performance of this Contract should the Purchaser cause a fire for which they would be liable under § 50-63-103, MCA.

## II. CHARGES AND PAYMENTS

### A. PERFORMANCE BOND:

1. As a guarantee of the faithful performance of this Contract, Purchaser shall furnish a bond, with sufficient sureties, to the State in an amount equal to the potential loss to the State in the event of Purchaser's breach or default under the terms of this Contract as determined by the Administrator (§ 77-5-202 (a), MCA). The performance bond may be in cash, bond, irrevocable letter of credit, or certificate of deposit with sufficient sureties. A letter of credit must be automatically renewable without amendment for the term of the contract. The performance bond the Purchaser must submit for this contract is shown in Table 1.
2. Upon full performance of the terms of the Contract, the State shall release the performance bond.
3. Upon substantial performance of the terms of the Contract, the Administrator may release a portion of the performance bond not needed to compensate the State for any remaining timber to be removed or any other losses that may be suffered by the State due to breach of Contract by the Purchaser. The bond shall not be reduced to less than five percent (5%) of the estimated value of the timber sold.

- B. PAYMENTS:** The Purchaser agrees to make payments to the Treasurer of the State of Montana as follows:

## TIMBER SALE CONTRACT

1. **ADVANCE STUMPAGE PAYMENTS:** The Purchaser is required to pay for all timber in advance of cutting at the rates shown in Table 1. Advance stumpage payments will be held by the State to cover the Purchaser's estimated timber cutting for at least six (6) weeks of operations. Advance stumpage payments may be reduced just before completion of the sale or when cutting requirements are to be suspended for at least 3 months. Advance stumpage payments may be in cash, bond, irrevocable letter of credit, or certificate of deposit with sufficient sureties.
2. **INITIAL ADVANCE STUMPAGE PAYMENT:** The initial advance payment will be made by the Purchaser prior to the start of timber cutting operations.
3. **PAYMENT SCHEDULE:** Payments in full for individual invoices will be made by the Purchaser as called for by the Administrator; in no event will payments be made by the Purchaser more than 14 days from the date of billing.
4. **FOREST IMPROVEMENT PAYMENTS:** The Purchaser is required to pay a fee for Forest Improvement on all sawlogs cut, both live and dead. The Forest Improvement fee for this sale is shown in Table 1. The Purchaser agrees to make these payments concurrently with stumpage payments. If the sale is completed before all the Forest Improvement payments have been made, the Purchaser will be billed for the balance owed.

### **C. ROAD USE AND MAINTENANCE PAYMENTS:**

1. **PAYMENTS:** The Purchaser is required to make payments for road use and maintenance at the rates listed in Table 1 or as amended by revisions to road use permits. Payments will be made as called for by the Administrator or as otherwise directed in this contract.
2. **ALTERNATE HAUL ROUTES:** The Purchaser is authorized by the State to use the haul route described in this contract and attachments. If the Purchaser chooses to use an alternate haul route, that haul route must be approved by the State. Road use charges, maintenance requirements and payments may be adjusted to reflect the haul route used by the Purchaser. The Purchaser is responsible for obtaining any right-of-way required for an alternate haul route and for meeting all requirements of any agreements associated with that right-of-way. Proof of any such agreement must be provided to the State prior to use. Stumpage fees and Forest Improvement fees are not subject to a downward adjustment under this clause.

## **III. MEASUREMENT AND LOG ACCOUNTABILITY**

### **A. PRODUCT MEASUREMENT:**

1. The State will determine the value of products removed from the sale based on the total gross weight of material hauled. Weight tickets will be used to obtain the total value.
2. When mixed products with different payment rates per ton are hauled on one load, the entire load will be charged at the rate of the product with the highest value contained in the load.
3. Upon request by the State, the most recent load delivered to a receiving mill must be made available for inspection by the State or their representatives. The weight ticket identifying the load must remain affixed to the load.

### **B. WEIGHT TICKETS:** The Purchaser is required to furnish weight tickets to the State as agreed to by the Forest Officer and the Purchaser.

1. All weight tickets shall be mailed or delivered with corresponding load tickets, as outlined below, directly to the DNRC Unit or Land Office administering this contract. In this case, send truck

## TIMBER SALE CONTRACT

tickets to the **Dillon Unit Office, 840 N Montana St, Dillon, MT 59725**. This requirement may be waived or changed by the Forest Officer.

2. Weight tickets shall show gross, tare and net weights and the corresponding load ticket number of each product load. Weight tickets must be from State of Montana certified scales, and all weight tickets must have mechanically stamped weights for the gross and tare weights unless otherwise permitted in writing by the Forest Officer. Weight tickets will be mailed or delivered to the State on a bi-weekly basis or as otherwise agreed to by the Forest Officer. A weight ticket will be considered as missing if not furnished within 4 weeks of the load delivery date. Failure to comply with this provision is a contract violation.
3. Truck ticket information may be provided to DNRC electronically if all required ticket information is provided. Contact Forest Product Sales Supervisor (406) 542-4276 at the Forest Management Bureau to implement electronic transfer. The information must be provided to the State on a bi-weekly basis prior to the tenth (10<sup>th</sup>) and twenty-fourth (24<sup>th</sup>) of each month. The paper copy of the weight tickets must also continue to be provided to the State. The requirement to supply the paper copy of the weight tickets may be waived by the Administrator.

**C. LOAD TICKETS:** The Purchaser will be issued load ticket books with consecutively numbered tickets for uniquely identifying truckloads of logs. A load ticket shall be attached to the driver's side bunk log of each product load prior to hauling, with the Scaler's copy given to the State from the delivery point. The Purchaser shall complete each ticket with the sale information required by the State. The Purchaser shall provide to the Forest Officer a complete list of destinations to which loads will be delivered. The State, at its discretion, may require a separate ticket book for each destination. Failure to comply with this provision is a contract violation.

**D. SORTING OF PRODUCTS:** The State may require separate ticket books for any loads sorted by the Purchaser by size or species or by specific products intended for different delivery points. Load tickets designated for a specific product must only be used for that specific product. When a load ticket is used with an incorrect product it is a contract violation.

**E. LOAD MARKING:** The Purchaser is required to mark all loads of logs before removal from the loading area to assist in identification while in transit or at the point of delivery. Marking shall be accomplished by painting "ST" in blue paint and the last three digits of the truck load ticket number on log ends of at least three logs on each load, both front and back. The driver's side bunk log shall be one of the marked logs. Failure to comply with this provision is a contract violation.

**F. PROMPT DELIVERY:** The Purchaser will deliver loads from the timber sale area to a receiving log yard directly without diversion. "Over-nighting" loads during transit are expressly forbidden unless approved by Forest Officer prior to hauling. Failure to comply with this provision is a contract violation.

**G. SCALE RULE:**

1. Any sawlogs scaled by the State shall be scaled using the Scribner Decimal "C" log rule. Log scaling will follow the procedures listed in the National Forest Log Scaling Handbook (FSH 2409.11) excluding Region 1 supplements.
2. In cases where conversion is required, a conversion factor of 8.20 tons per thousand board feet will be used for sawlogs.

## IV. CONTRACT VIOLATIONS AND PENALTIES

### A. SUSPENSION:

1. **FAILURE TO PAY ADVANCE STUMPAGE:** If Purchaser fails to submit advance stumpage payments as directed by the Administrator pursuant to the terms of this Contract within 30 days of the request for such payments, all operations covered by this Contract shall immediately cease upon written or oral order from the State until all required advance stumpage payments, or guarantee of payment satisfactory to the State, have been made. The cutting and removal of timber may resume only upon receipt of written notice to the Purchaser from the State that acknowledges adequate payment or guarantee.
2. **LOSS OF BOND:** If the surety bond or other bond securing performance of this Contract is canceled or otherwise becomes ineffective, operations covered by this Contract shall immediately cease upon written or oral order from the State to the Purchaser. Cutting and removal of timber may resume only upon receipt of written notice from the State that acknowledges adequate bond.
3. **OTHER CONTRACT VIOLATIONS:**
  - a. Should the Forest Officer observe a condition that violates the terms of this Contract, the Forest Officer may verbally notify the Purchaser or its employees or subcontractors of such condition and immediately suspend all or part of the operations in the sale area to prevent harm to the interests of the State or the public. Should the Purchaser or its employees or subcontractors fail to comply with any verbal suspension order, the Administrator may terminate the Contract pursuant to Section IV. B. Termination. The Forest Officer may rescind his/her verbal suspension order upon satisfactory cure of the Purchaser's violation and operations may resume.
  - b. Suspension orders may be given in writing or verbally to the Purchaser, or to his, her or its employees or subcontractors. Once given, the Purchaser, and his, her or its employees or subcontractors shall immediately comply with such order of suspension and failure to do so shall constitute grounds for termination of this Contract. Suspension orders are reviewable under the provisions described in Section I.I. COMPLAINTS.
  - c. The Administrator may issue a written notice of suspension depending upon the severity of the violation and Purchaser's ability to cure. Such notice shall contain information regarding:
    1. The breach observed and harm anticipated;
    2. The contract provisions violated;
    3. If possible, the measures required to cure the violation and allow operations to resume; and
    4. The deadline within which the Purchaser must cure the violation.Should the Purchaser fail to cure the violation as required, or to obtain a written variance from the Administrator, the Administrator may charge the Purchaser a \$250 per day penalty for every day that the violation persists. Operations may resume only upon written notice from the Administrator. If satisfactory measures or remedies cannot be found to cure the violation, the Administrator may immediately terminate the Contract pursuant to Section IV.B. TERMINATION.

### B. TERMINATION:

1. Gross or persistent contract violations and/or failure to promptly and properly remedy contract violations by the Purchaser pursuant to the terms of this Contract shall be grounds for termination of the Contract by the State.
2. If this Contract is terminated by the State, the Administrator shall immediately notify the Purchaser of the termination and the reasons for it by certified mail. Such notice shall describe in what respects the Contract has been breached, the means, if any, by which the breach can be remedied and the consequences of such termination. The Contract shall be terminated 18 days from the date the notice is mailed to the Purchaser at the address stated in this Contract.

## TIMBER SALE CONTRACT

3. Upon receipt of the notice of termination the Purchaser shall immediately cease all operations pursuant to and permitted by the contract until the termination is resolved as provided pursuant to this Section of the Contract, Section IV.B. TERMINATION.
4. The Purchaser has 18 days after mailing of the notice of termination within which to file with the State a notice of appeal for a hearing before the Board of Land Commissioners or its appointee. If a timely notice of appeal is filed, the Contract remains in effect until the decision of the Board, but any suspension order shall remain in effect in the interim. The Board or its appointee shall conduct an informal open hearing to determine whether the Contract should be reinstated.
5. If the Contract is reinstated the Purchaser will not be penalized for any delays that resulted from the appeal.
6. If the Contract is terminated for breach and not reinstated, it is understood that the State may refuse to accept bids or proposals submitted under 77-5-212 MCA from the Purchaser on future State timber sales and permits for a minimum period of 2 years.

### **C. LIABILITY FOR DAMAGES:**

1. The Purchaser shall be liable for any damages sustained by the State arising from Purchaser's breach of the terms of this Contract and the State may cause all or part of the performance bond to be forfeited to recover such damages.
2. In the event that a portion of the timber sale under this Contract is resold as a result of the Purchaser's forfeiture and the stumpage rate pursuant to the resold contract is lower than the stumpage rate provided herein, the difference between the original rate and the new rate shall be considered damages and the Purchaser shall be liable to the State for those damages. The State may cause all or part of the Purchaser's performance bond to be forfeited to recover such damages.

**D. STATE'S OPTION TO COMPLETE CONTRACT REQUIREMENTS:** If the Purchaser fails to complete the requirements described in this Contract in a timely manner or if the Contract is terminated pursuant to Section IV.B. TERMINATION, the State reserves the right to complete the work itself or through a contractor. The Purchaser will be billed for any additional costs incurred by the State due to the Purchaser's failure to perform the requirements of this Contract. These additional costs may include State employee time and expenses that were extraordinary to the normal administration of the contract, such as time and expenses incurred to hire a replacement contractor. Purchaser's failure to make payment within 14 days from the date of billing may cause all or part of the performance bond to be forfeited to recover such costs.

**E. WAIVER OF PENALTIES:** The penalties specified in this section shall be regarded as liquidated damages and may be waived or reduced at the discretion of the Administrator in exceptional cases.

**F. FOREST PRACTICES LAWS:** The Purchaser shall conduct logging operations in compliance with all laws relating to forest practices in the State of Montana. The Purchaser shall be responsible for all reclamation and penalties that result from violations of applicable forest practices laws.

### **G. LOGGING REQUIREMENT VIOLATIONS:**

1. **HIGH STUMPS:** The Purchaser may be charged \$25.00 for each tree stump cut higher than 12 inches on the side adjacent to the highest ground except in unusual cases when this height is not considered practical.
2. **LONG BUTTS:** The Purchaser may be required to pay \$25.00 per long butt for cutting long butts that contain useable material in excess of the minimum net scale in percentage of gross shown in Table 2.

## TIMBER SALE CONTRACT

3. **LARGE TOPS:** The Purchaser may be required to pay for cutting tops larger than the Top Diameter Inside Bark (DIB) shown in Table 2. This charge will be at the current contract rate for the net volume by species, or \$25.00 per large top, whichever is greater.
4. **UNDESIGNATED TREES:**
  - a. Undesignated or reserve trees that are cut or damaged as a result of Purchaser's operations shall be considered cut in trespass and the Purchaser may be charged three times the highest Contract stumpage rate (minimum \$10.00/ton) for the Contract product class(es) the tree contains.
  - b. If the Forest Officer determines that a suitable replacement for a reserve tree as described above is not available, Purchaser agrees to pay the State \$500.00 per tree, in addition to the rates charged in Section IV.G.4.a. UNDESIGNATED TREES.
5. **FAILURE TO REMOVE:** The State may charge the Purchaser for trees that are designated for cutting under the terms of this contract and/or logs that meet the Manufacturing and Recovery Standards shown in Table 2 that are not removed from the sale area or presented for measurement. This charge may be up to triple the Contract stumpage rate plus the Forest Improvement rate for the class of material contained in those trees fixed in accordance with the terms of this Contract. If the State removes such material from the sale area, the Purchaser will be required to reimburse the State for all applicable cutting, yarding, processing, loading and hauling costs.
6. **LOSS IN WEIGHT DUE TO PURCHASER DELAY:** Up to a 15% increase in net weight of logs will be added by the State for loss in weight due to delay by the Purchaser in delivering cut logs to the manufacturing point. A delay is defined as in excess of 30 days after felling.

### **H. MEASUREMENT AND LOG ACCOUNTABILITY VIOLATIONS:**

1. **MISSING LOAD TICKETS:** The Purchaser will be charged up to \$500.00 for each unused load ticket that the Purchaser has lost or misplaced while in his, her or its possession. An unused ticket is defined as a ticket that is not turned into the State with an associated truckload weight.
2. **FAILURE TO ATTACH OR COMPLETE LOAD TICKET:** The Purchaser may be charged \$500.00 per load for failure to attach a load ticket to each product load prior to hauling, or for failure to complete the load ticket with all required information.
3. **MISSING WEIGHT TICKETS:**
  - a. The Purchaser will be charged up to triple the Contract stumpage rate plus the Forest Improvement rate  $[(\text{stumpage} + \text{FI}) \times 3 = \text{penalty}]$  for each truck weight ticket not furnished to the State.
  - b. The Forest Officer will notify the Purchaser of each missing weight ticket.
  - c. The load weight will be determined by averaging weights from other loads hauled by the Purchaser to the same mill within the same billing period, or 30 tons for single loads and 38 tons for loads with a pup trailer attached.
  - d. For Other Material, as defined by this Contract, the minimum stumpage for purposes of penalty shall be \$10.00 per ton or the Contract stumpage rate multiplied by 3, whichever is higher. The Forest Improvement fee is not included in Other Material penalties.
4. **IMPROPERLY LABELED PRODUCT:** The Purchaser may be charged \$500.00 per load for loads with an incorrect load ticket for the product (Sawlog or Other Material) in the load. In addition, the stumpage paid for an improperly ticketed load shall be at the highest Contract stumpage rate for products hauled pursuant to this Contract.

## TIMBER SALE CONTRACT

5. **IMPROPERLY MARKED LOADS:** The Purchaser may be charged \$40.00 per load for each load not marked in accordance with Section III.E. LOAD MARKING.

### I. RESOURCE PROTECTION VIOLATIONS:

1. The Purchaser may be charged five hundred dollars (\$500.00) per piece of equipment determined to have entered sale area without Forest Officer inspection in accordance with VI.J. NOXIOUS WEED MANAGEMENT. This charge does not relieve the Purchaser from requirement VI.J. NOXIOUS WEED MANAGEMENT.

- J. FAILURE TO MEET COMPLETION DATES:** The Purchaser may be charged \$100.00 for each complete calendar day the Purchaser fails to meet the deadlines shown in Table 3 and Table B1.

- K. LATE PAYMENTS:** The Purchaser may be charged \$100.00 per day beginning the 15th day after the billing date for failure to pay for forest products, pursuant to Section II.B PAYMENTS.

## V. FIRE PROTECTION

- A. FIRE REGULATIONS:** The Purchaser is required to conduct all operations in accordance with the Montana Forest Fire Regulations, Attachment C.

- B. FIRE PREVENTION:** During the time that this Contract remains in force, the Purchaser shall, to the greatest extent practicable, prevent forest fires on the area described in this Contract and in its vicinity, and shall require all employees, contractors and employees of contractors to do likewise.

- C. OPEN BURNING REQUIREMENTS:** The Purchaser is required to conduct any burning of slash or other debris in accordance with the Montana Department of Environmental Quality open burning restrictions. The Forest Officer must be notified prior to the start of any burning operations.

- D. FIRE SUPPRESSION:** Unless prevented by circumstances over which he, she or it has no control, the Purchaser shall place qualified employees, contractors and employees of contractors and all equipment at the disposal of any authorized State, County, or Federal Forest Officer for the purpose of fighting forest fires. Payment for such services shall be made at rates to be determined by the Forest Officer, which shall be within a range of payment rates shown in the Interagency Incident Business Management Handbook, NWCG Handbook 2. Any employees or equipment furnished by the Purchaser, contractors or employees of contractors, shall be relieved from fire fighting as soon as it is practicable for the Forest Officer to obtain other adequate labor or equipment.

- E. FIRE COSTS:** The costs borne by the State for suppressing fires that are intentionally lit by the Purchaser or that are caused by negligence or fault in the Purchaser's operations shall be paid by the Purchaser to the State. The Purchaser shall also be liable for property and resource damage resulting from these fires.

- F. FIRE REPORTING:** Any wildfires, which the Purchaser detects or suppresses, must be reported as soon as possible to the responsible fire protection agency and the Department.

- G. SUSPENSION OF OPERATIONS:** When fire danger reaches extreme levels that cause operations to be curtailed through Stage II, Hoot Owl requirements or other measures, the State may suspend operations until fire conditions in and/or around the sale area improve. The State will grant a contract extension to compensate for the time suspended.

- H. CONTACT INFORMATION:** The Purchaser will provide the Forest Officer with phone numbers of the Purchaser and their employees and contractors when logging operations are in progress (including nights and weekends), in order to establish contact if a wildfire occurs within the sale area or on other lands accessed by road systems associated with the sale.

## VI. RESOURCE PROTECTION

- A. DAMAGE PREVENTION:** The Purchaser shall use reasonable skill and care in all operations to prevent damage to soils, trails, meadows, stream banks, stream channels, wetlands, lakeshores or other natural features of the sale area.
- B. STREAM PROTECTION:**
1. Construction and logging equipment will not be operated in Streamside Management Zones. An exception may be provided for through this Contract or the Forest Officer may grant written permission. Additional protection measures may be required in Section VII.G, SPECIAL OPERATING REQUIREMENTS and in Contract Attachments.
  2. The Purchaser shall notify the Forest Officer immediately if debris from logging or construction enters a stream or stream channel.
  3. The Purchaser shall remove any debris resulting from logging or construction operations, which may affect the natural flow of any streams traversing the sale area. This work will be completed in a manner that causes the least disturbance to the streams, as directed by the Forest Officer.
  4. Logs shall not be hauled, skidded or yarded across streams unless the logs are fully suspended, or otherwise yarded as specified in this Contract. The Forest Officer must approve all logging and construction plans, including changes, before implementation.
  5. All operations shall be conducted in a manner to comply with Montana Water Quality Standards, the Streamside Management Zone Law, and all applicable permits.
- C. CULTURAL RESOURCES:** If a cultural resource is discovered, the Purchaser shall immediately suspend all operations in the vicinity of the cultural resource and notify the Forest Officer. Operations may only resume if authorized by the Forest Officer. Cultural resources identified and protected elsewhere in this contract are exempted from this clause. Cultural resources, once discovered or identified, are not to be disturbed by the Purchaser, or his, her or its employees and/or sub-contractors.
- D. DISCOVERY OF THREATENED AND ENDANGERED SPECIES:**
1. If a specific habitat feature for a federally listed threatened or endangered species is encountered, the Purchaser shall suspend all operations in the vicinity of the observation or discovery and immediately notify the Forest Officer. Operations may resume only if authorized by the Forest Officer. Habitat features identified and protected elsewhere in this contract are exempted from this clause.
  2. If a federally listed threatened or endangered species is encountered, the Purchaser shall immediately notify the Forest Officer. The Purchaser may be required to suspend operations in the vicinity of the observation or discovery. If suspended, operations may resume only if authorized by the Forest Officer.
- E. SANITATION:** The Purchaser's operations, as described by this contract, shall comply with all applicable State laws, rules and regulations concerning sanitation in operations. Refuse resulting from the Purchaser's activities, including the use, servicing, repair, or abandonment of equipment, shall be removed, buried or otherwise disposed of in a manner that complies with all State laws and meets the approval of the Forest Officer. The Purchaser shall not service tractors, trucks and similar pieces of equipment on lands that directly drain into or are within 100 feet of lakes, streams or recreational facilities. No logging camp will be located on the gross sale area without prior approval by the Forest Officer.



## TIMBER SALE CONTRACT

- F. HAZARDOUS SUBSTANCES:** In addition to the indemnification provided in Section I.W.2. INDEMNITY AND LIABILITY, with respect to Hazardous Substances, the following duties shall apply:
1. The Purchaser shall know and comply with regulations governing the storage, handling, application, disposal, and reporting of pesticides, herbicides, containers, biological waste, petroleum products, dust abatement compounds, and other hazardous substances. The Purchaser shall obtain the approval of the Forest Officer to store, handle, apply or dispose of these substances on State land.
  2. The Purchaser shall not transport, handle, store, load, apply, or dispose of any hazardous substance in such a manner as to pollute water supplies or waterways, or cause damage or injury to people, land, desirable plants, and animals.
- G. PROTECTION OF IMPROVEMENTS:** The Purchaser shall to the greatest extent practicable protect from damage all gates, signs, telephone lines, power lines, fences, irrigation ditches, cattle guards, drainage structures, road improvements, and any other improvements or infrastructure within the gross sale area and/or along haul routes. Damages caused by the Purchaser, his, her or its employees or subcontractors, and expenses associated with the repair or replacement of damaged structures and improvements are the sole responsibility of the Purchaser.
- H. PROPERTY CORNER RESTORATION:** The Purchaser is required to replace any General Land Office township, section, quarter or meander corners, monuments or witness trees on or adjacent to the timber sale area which may have been moved, disturbed or lost, as a result of the Purchaser's logging or construction operations. Any necessary replacements must be carried out by a licensed surveyor at the Purchaser's expense.
- I. PASSABLE ROADS:** The Purchaser will leave all roads and trails free from obstruction by logs, brush or debris following the completion of logging operations. Temporary or permanent obstructions may be acceptable if approved by the Forest Officer.
- J. NOXIOUS WEED MANAGEMENT:** All equipment used in road construction and off-road logging activity must be pressure-washed by the Purchaser and inspected by the Forest Officer prior to entering the sale area. This cleaning will remove all dirt, plant parts, and material that may carry noxious weed seeds into the sale area. Other equipment and vehicles entering and leaving the sale area shall be cleaned prior to start up and kept reasonably clean during the course of operations. All subsequent move-ins of logging and construction equipment shall be treated the same as the initial move-in.
- K. WILDLIFE PROTECTION:**
1. The Purchaser is authorized to enter areas closed by gates, barricades or berms with motorized vehicles only for the purposes related to the performance of this contract. Motorized vehicle entry for purposes other than contract performance, such as hunting or transporting game animals will be considered trespass and prosecuted to the fullest extent of the law (Montana Code Annotated § 45-6-203).
  2. The Purchaser is prohibited from carrying firearms while conducting contract operations [ARM 36.11.432(1)(m); 36.11.433(1)(d); 36.11.443(2)].
  3. The Purchaser will store human or pet food, livestock food, garbage, and other attractants in a bear-resistant manner.
  4. The Purchaser will not bury or discard attractants in the sale area, or burn attractants (such as food leftovers) in an open campfire.
  5. The Purchaser will provide each employee with a copy of Attachment D "Working in Bear Habitat" Brochure.

## VII. LOGGING

**A. TREES DESIGNATED FOR CUTTING:** All trees meeting the following requirements must be cut by the Purchaser.

1. **TREES IN UNITS:** Trees that meet the Minimum Log Size of Trees Designated for Cutting in Table 2 are to be cut in each unit according to the Marking specifications shown in Section VII.F. UNIT DESIGNATIONS.
2. **RIGHT-OF-WAY TREES:** All trees within road right-of-way boundaries must be cut.
3. **DAMAGED TREES:** Reserved trees, which are root-cut, damaged by felling or skidding, uprooted or broken off by the Purchasers operations may be designated for cutting by the Forest Officer. The Forest Officer may mark additional reserve trees to replace those that have been cut or damaged.
4. **FIRE KILL, INSECT INFESTATIONS AND WIND THROWN:** The Purchaser may be required to cut and remove at current contract rates, fire-killed, high hazard, disease infected, insect-infested or wind thrown (defined as blown down or wind-damaged to the extent that the tree is expected to fall or is dying) trees that occur in any part of the gross sale area while this Contract is in effect, if the Forest Officer determines that the stumpage value per ton of the additional timber is approximately equal to the value of the timber being harvested under this Contract .

**B. TREES RESERVED FROM CUTTING:**

1. **LEAVE TREES:** Trees, both live and dead, marked to leave or otherwise described to leave are reserved from cutting. Any trees not specifically required to be cut are reserved from cutting.
2. **BOUNDARY AND BEARING TREES:** Trees marking the boundaries of ownership, logging units, equipment restriction zones, streamside management zones, road rights-of-way, and bearing trees, are reserved from cutting unless otherwise designated by this contract or by the Forest Officer.
3. **VALID CLAIMS:** Timber to which there exists a claim under valid contracts with the State of Montana is exempted from this sale.

**C. LOG MANUFACTURING AND RECOVERY STANDARDS:**

1. **SAWLOG STANDARDS:** Trees cut by the Purchaser shall be manufactured to secure the maximum utilization of forest products according to III.G.1. All logs that meet or exceed the Manufacturing and Recovery Standards in Table 2 and this section shall be skidded to landings and hauled by the Purchaser.
  - a. Logs shall be bucked to utilize the entire length of the tree to the top diameter specified under Manufacturing and Recovery Standards in Table 2.
  - b. Logs meeting utilization specifications in Table 2 shall be manufactured in such a manner as to minimize waste during bucking operations.
  - c. A tree or log larger than 5.6" top DIB is considered to be a sawlog if it contains Scribner Decimal C Net Scale  $\geq$  33% of Gross.
2. **OTHER MATERIAL:** The Purchaser may elect to remove other material that does not meet Sawlog Manufacturing and Recovery Standards in Table 2, only if approved by the Forest Officer. Such products shall be billed at the rate for other material shown in Table 1.
  - a. All contract provisions apply to the removal of Other Material.

TIMBER SALE CONTRACT

- b. Other Material that has been manufactured by the Purchaser shall be decked and hauled separately from sawlogs. All decked non-sawlog material must be hauled, or disposed of by the Purchaser in accordance with instructions of the Forest Officer. All hauled loads will have a truck ticket assigned and will meet the specifications in Section III, MEASUREMENT AND LOG ACCOUNTABILITY.
  - c. Butt cut logs (the first log cut above the stump) that meet LOG MANUFACTURING AND RECOVERY STANDARDS in Table 2, but do not meet TREES DESIGNATED FOR CUTTING minimum top DIB and length, may be considered as Other Material, not sawlogs.
3. DOWN WOODY MATERIAL: **15 to 20** tons per acre of downed woody material larger than 3 inches in diameter shall be left scattered throughout the sale units. The Forest Officer will determine the appropriate amount of material and may designate pieces to be left for this purpose that would otherwise be skidded and hauled under Sections VII.C.1 or VII.C.2, LOG MANUFACTURING AND RECOVERY STANDARDS.
  4. NUTRIENT RETENTION: Removal from the site of fine branches and leafy material shall be minimized.
  5. SNAGS: The Purchaser will retain a minimum of 2 snags per acre and 2 recruitment trees per acre that are >21 inches dbh within each harvest unit unless superseded by Section VII.F, UNIT DESIGNATIONS. If snags and recruitment trees of this size class are not available, the next largest available size class shall be retained. If snags present human safety concerns, the Purchaser may substitute snag recruits for snags upon approval of the Forest Officer. Snags cut for safety purposes shall remain in the unit.

TABLE 2.					
PRODUCT	TREES DESIGNATED FOR CUTTING		SAWLOG MANUFACTURING AND RECOVERY STANDARDS		
	The Purchaser must fell all trees marked or designated for cutting that contain a log of this minimum size.		The Purchaser must skid and haul all logs that meet this minimum specification.		
	Top DIB	Length	Top DIB	Length	Sawlogs meeting standards in Section VII.C.1.b through c
Sawlogs	5.6"	16.5'	5.6" - 8.5" 8.6"+	10.5' 8.5'	
Other Material (Firewood, optional?)	5.5"	25'	5.5"	25'	

**D. TREE AND BOUNDARY MARKING:**

1. TREES MARKED TO CUT: n/a
2. TREES MARKED TO LEAVE: n/a
3. HARVEST UNIT BOUNDARIES: Marked with three horizontal **blue** paint stripes facing into the unit.

TIMBER SALE CONTRACT

- 4. ROAD RIGHT-OF-WAY BOUNDARIES: Marked with **red** paint spots facing toward the road centerline.
  - 5. PROPERTY BOUNDARIES: n/a
  - 6. STREAMSIDE MANAGEMENT ZONES: The State has marked with fluorescent **orange** flagging stenciled with "STREAMSIDE MANAGEMENT ZONE".
  - 7. EQUIPMENT RESTRICTION ZONES: Marked with **orange and black** striped flagging.
- E. HARVEST SCHEDULE:** The Purchaser must cut and remove trees from the sale or portions of the sale, such as units, by the dates shown on the HARVEST COMPLETION SCHEDULE, Table 3:

TABLE 3. HARVEST COMPLETION SCHEDULE		
Priority	Unit or Portion of Sale	Completion Date
1	All	October 1, 2028

- F. UNIT DESIGNATIONS:** The following requirements are to be performed by the Purchaser in the harvest units listed below and as shown on the sale map, Attachment A. Paragraph headings refer to paragraphs listed in Section VII.G, SPECIAL OPERATING REQUIREMENTS.

TIMBER SALE CONTRACT

HARVEST UNIT NUMBER(S)	ACRES	ESTIMATED VOLUME (Tons)
1	64	3,862
YARDING METHOD: Tractor		
MARKING: Purchaser Selection		
OPERATING PERIOD: Year-round as conditions permit		
SPECIAL OPERATING REQUIREMENTS: 1. PURCHASER CUT TREE SELECTION 2. RESERVED SUBMERCHANTABLE TREE PROTECTION 3. SLASH REDUCTION		
HARVEST UNIT NUMBER(S)	ACRES	ESTIMATED VOLUME (Tons)
2	34	1,893
YARDING METHOD: Tractor		
MARKING: Purchaser Selection		
OPERATING PERIOD: Year-round as conditions permit		
SPECIAL OPERATING REQUIREMENTS: 1. PURCHASER CUT TREE SELECTION 2. RESERVED SUBMERCHANTABLE TREE PROTECTION 3. SLASH REDUCTION		
HARVEST UNIT NUMBER(S)	ACRES	ESTIMATED VOLUME (Tons)
3	26	1,306
YARDING METHOD: Tractor		
MARKING: Purchaser Selection		
OPERATING PERIOD: Year-round as conditions permit		
SPECIAL OPERATING REQUIREMENTS: 1. PURCHASER CUT TREE SELECTION 2. RESERVED SUBMERCHANTABLE TREE PROTECTION 3. SLASH REDUCTION		
HARVEST UNIT NUMBER(S)	ACRES	ESTIMATED VOLUME (Tons)
4	45	3,862
YARDING METHOD: Tractor		
MARKING: Purchaser Selection		
OPERATING PERIOD: Year-round as conditions permit		
SPECIAL OPERATING REQUIREMENTS: 1. PURCHASER CUT TREE SELECTION 2. RESERVED SUBMERCHANTABLE TREE PROTECTION 3. SLASH REDUCTION		

TIMBER SALE CONTRACT

<b>HARVEST UNIT NUMBER(S)</b>	<b>ACRES</b>	<b>ESTIMATED VOLUME (Tons)</b>
5	25	1,010
YARDING METHOD: Tractor		
MARKING: Purchaser Selection		
OPERATING PERIOD: Year-round as conditions permit		
SPECIAL OPERATING REQUIREMENTS: 1. PURCHASER CUT TREE SELECTION 2. RESERVED SUBMERCHANTABLE TREE PROTECTION 3. SLASH REDUCTION 4. CONSTRUCTED SKID TRAIL RECLAMATION		
<b>HARVEST UNIT NUMBER(S)</b>	<b>ACRES</b>	<b>ESTIMATED VOLUME (Tons)</b>
6	30	1,312
YARDING METHOD: Tractor		
MARKING: Purchaser Selection		
OPERATING PERIOD: Year-round as conditions permit		
SPECIAL OPERATING REQUIREMENTS: 1. PURCHASER CUT TREE SELECTION 2. RESERVED SUBMERCHANTABLE TREE PROTECTION 3. SLASH REDUCTION		
<b>HARVEST UNIT NUMBER(S)</b>	<b>ACRES</b>	<b>ESTIMATED VOLUME (Tons)</b>
7	37	1,275
YARDING METHOD: Tractor		
MARKING: Purchaser Selection		
OPERATING PERIOD: Year-round as conditions permit		
SPECIAL OPERATING REQUIREMENTS: 1. PURCHASER CUT TREE SELECTION 2. RESERVED SUBMERCHANTABLE TREE PROTECTION 3. SLASH REDUCTION 4. CONSTRUCTED SKID TRAIL RECLAMATION		

TIMBER SALE CONTRACT

HARVEST UNIT NUMBER(S)	ACRES	ESTIMATED VOLUME (Tons)
8	15	601
YARDING METHOD: Tractor		
MARKING: Purchaser Selection		
OPERATING PERIOD: Year-round as conditions permit		
SPECIAL OPERATING REQUIREMENTS: 1. PURCHASER CUT TREE SELECTION 2. RESERVED SUBMERCHANTABLE TREE PROTECTION 3. SLASH REDUCTION		
HARVEST UNIT NUMBER(S)	ACRES	ESTIMATED VOLUME (Tons)
9	71	1,084
YARDING METHOD: Tractor		
MARKING: Purchaser Selection		
OPERATING PERIOD: Year-round as conditions permit		
SPECIAL OPERATING REQUIREMENTS: 1. PURCHASER CUT TREE SELECTION 2. RESERVED SUBMERCHANTABLE TREE PROTECTION 3. SLASH REDUCTION 4. CONSTRUCTED SKID TRAIL RECLAMATION		
HARVEST UNIT NUMBER(S)	ACRES	ESTIMATED VOLUME (Tons)
10	3	120
YARDING METHOD: Tractor		
MARKING: Purchaser Selection		
OPERATING PERIOD: Year-round as conditions permit		
SPECIAL OPERATING REQUIREMENTS: 1. PURCHASER CUT TREE SELECTION 2. RESERVED SUBMERCHANTABLE TREE PROTECTION 3. SLASH REDUCTION 4. CONSTRUCTED SKID TRAIL RECLAMATION		

**G. SPECIAL OPERATING REQUIREMENTS:** The following requirements are to be performed by the Purchaser in specific sale units as shown in Section VII.F, UNIT DESIGNATIONS.

1. PURCHASER CUT TREE SELECTION: The purchaser will be responsible for cut tree selection in each harvest Unit as specified in Attachment G, Designation by Description .

If the Purchaser fails to meet the cutting specifications, cutting operations will be suspended and the Forest Officer will require leave trees to be marked by the Purchaser, and the marking to be approved by the Forest Officer prior to harvest.

## TIMBER SALE CONTRACT

2. **RESERVED SUBMERCHANTABLE TREE PROTECTION:** Care shall be exercised in felling and skidding operations to minimize damage to conifer regeneration. If damage is excessive as determined by the Forest Officer, operations may be suspended until suitable arrangements are made to reduce damage. This stipulation does not apply to mature trees in the intermediate and suppressed canopy.
3. **SLASH REDUCTION:** In the event slash accumulations within the harvest unit exceeds DNRC recommended maximum fuel loading specifications (during harvest or upon completion), Purchaser may be required to spot pile, lop, trample or yard excessive material to landing piles. Woody debris (slash) consists of dead and green material that has occurred naturally or from harvest operations. Fuel loading determination is based on slash size class, weight (tons per acre), and slope that will result in a maximum flame length of 4' with ignition. All areas determined to exceed desired fuel loads greater than 2 acres may be designated for treatment. The Montana DNRC Photo Series Handbook for Appraising Timber Slash in Montana will be used to evaluate slash hazard conditions for this sale activity. Portions of units within 100 feet of property boundaries, public access roads, railroads and powerline corridors must meet the 4-foot flame length standard. The 4-foot flame length standard is defined as 90% of the area logging slash being reduced to a level at which a fire starting under conditions similar to a "Standard Day" (87 degrees, 17% RH, 12 mph wind speed) would burn with a flame length of 4 feet or less as calculated by the BEHAVE model.
4. **CONSTRUCTED SKID TRAIL RECLAMATION:** All constructed skid trails will be reclaimed after use. This includes installing drainage features and reshaping to near natural contours. Use of an excavator is required.

**H. LOGGING OPERATIONS PLAN:** The Forest Officer shall approve a plan for felling, yarding, and landing logs (both Sawlogs and Other Material) in each harvest unit prior to the start of operations in that unit.

**I. SKID TRAIL LAYOUT AND YARDING PLAN:** The Purchaser must follow these requirements along with those shown under VII.G. SPECIAL OPERATING REQUIREMENTS when developing a yarding plan for each unit. The Forest Officer may approve exceptions to these requirements in writing.

1. The Purchaser shall lay out skid trails and have locations approved by the Forest Officer prior to felling trees.
2. All skid trails will be located within the harvest unit boundaries.
3. Any constructed skid trails shall be completed and approved by the Forest Officer prior to felling timber.
4. Skid trails will not be located in draws, and may only cross draws at locations flagged and approved by the Forest Officer.

**J. LANDINGS AND LOG DECKS:**

1. The Purchaser shall construct landings at locations approved by the Forest Officer prior to felling timber.
2. Landings shall be kept to the minimum size necessary to allow the safe handling of logs. The Forest Officer must approve landing size.
3. All deck locations shall be approved by the Forest Officer prior to clearing or use. Decks shall be located so as to minimize the number of trees cut for construction of the deck area.

**K. FELLING:**



## TIMBER SALE CONTRACT

1. In each harvest unit, a felling pattern shall be used which conforms to the logging operations plan and causes the least damage to reserve trees and other resources.
2. Felling shall be systematic and continuous to avoid lost logs and minimize the number of skidding trips.
3. Trees shall be directionally felled away from features requiring protection within or adjacent to harvest units. Features requiring protection include streams, meadows, wet areas, and areas specified under Section VII.F. UNIT DESIGNATIONS. Wedges, jacks, winches, or other special equipment may be required to direct trees when felling. Trees falling into protection areas shall be winch-line skidded out of protected features. All necessary mitigation for damage caused by improper and/or non-approved felling into a protected zone is the responsibility of the Purchaser. The Forest Officer must approve all mitigation work.
4. Traffic Control Required For Felling along Roads: If felling operations occur along public roads, traffic guards with "STOP" signs shall be posted 500 feet in both directions from the units on open roads, providing a safety zone to warn oncoming traffic that logging operations are in progress. All traffic shall be stopped when tree felling is in progress. Traffic stops should not exceed 15 minutes at any one time. All saws will be shut off when traffic is moving through the safety zone. Wedges and/or jacks shall be used to ensure trees do not fall onto the roadway. In the event a tree falls across the roadway, all debris shall be removed immediately from the roadway and right-of-way. The Forest Officer must approve any extended road closures for logging operations.

**L. YARDING AND MECHANICAL FELLING:** The Purchaser must follow these requirements during logging operations, along with those shown under Section VII.G. SPECIAL OPERATING REQUIREMENTS. The Forest Officer will determine when restrictive conditions apply, and may approve exceptions to these requirements in writing.

1. Soil Compaction Restrictions: In order to prevent soil resource impacts, ground-based mechanical felling and yarding are restricted to periods when one or more of the following conditions occur:
  - a. Soil moisture content at 4-inch depth less than 20% oven-dry weight.
  - b. Minimum frost depth of 4 inches.
  - c. Minimum snow depth of 18 inches, loose, or 12 inches, packed.
2. Suspended Operations for Soil Compaction and Displacement: The Purchaser will be required to restrict or suspend logging operations when soils are subject to compaction or displacement by heavy equipment.
3. Equipment Restrictions:
  - a. Equipment shall not be operated in areas designated as EQUIPMENT RESTRICTION ZONES, WETLAND MANAGEMENT ZONES or STREAMSIDE MANAGEMENT ZONES as shown in Section VII.D.6 and 7, unless authorized by this Contract or the Forest Officer.
  - b. Equipment shall not be operated in soft soils, boggy areas or areas where skidding would cause excessive compaction and displacement.
  - c. Any trees designated for harvest within such zones shall be winchline skidded to skid trails outside the zone.
  - d. Slash will not be piled in or pushed into these zones.
  - e. The Forest Officer must approve any designated crossings of restricted areas.

## TIMBER SALE CONTRACT

4. Protection of Reserved Trees: The Purchaser shall exercise reasonable care to prevent damage to trees reserved from cutting during logging operations.

**M. CLEAN-UP AND COMPLETION:** The Purchaser must follow these requirements and those shown under Section VII.G. SPECIAL OPERATING REQUIREMENTS during logging operations. The Forest Officer will determine when restrictive conditions apply, specifications and dates to meet these requirements and may approve exceptions in writing. The Forest Officer must approve all designated work prior to the removal of Purchaser's equipment.

1. Logging Debris Confined To Units: All debris from logging shall be confined within the harvest unit boundaries. Any logging debris outside a harvest unit must be returned to within the unit boundary.
2. Skidding Debris on Roads: The Purchaser shall remove logging slash remaining on any portion of a road cutbank or traveled way. Cut and fill slopes, ditches, or road surfaces damaged by skidding operations shall be restored to original conditions. Reseeding is required if vegetation is damaged by skidding.
3. Repair of Improvements: Damage caused by the Purchaser's operations to culverts, waterlines, fences, roads, bridges, gates, cattleguards, signs, and all other improvements must be adequately repaired or replaced.
4. Erosion Control:
  - a. The Purchaser shall construct slash and debris erosion barriers, dips, water bars or ditches in skid trails and landings as directed by the Forest Officer.
  - b. The kinds and frequency of erosion control structures shall be adjusted to soil types, topography and climatic conditions as directed by the Forest Officer.
  - c. The Purchaser is required to recontour any excavated skid trails, and provide for effective erosion control in the trail location as directed by the Forest Officer.
  - d. Erosion control work shall commence as soon as skidding is completed on each skid trail or landing, and must be kept current with unit operations.
  - e. Erosion control work shall be completed and approved by the Forest Officer in unfinished units before operations cease for inactive periods including heavy winter snowfall, spring breakup and restricted dates.
  - f. All erosion control work in each unit shall be completed prior to notification pursuant to Section VII.M.7. Acceptance of Completed Harvest Units.
  - g. The Purchaser shall maintain erosion control structures in active sale areas throughout the contract period or extensions thereof.
5. Landing and Decking Area Cleanup: The Purchaser is required to pile logging residues on landings and log-decking areas. Proper equipment (e.g. brush blade, log loader) shall be used to ensure that no dirt is incorporated into the piles. Mechanical scarification of landing and decking areas may be required. Where logs have been decked on the downhill or fill side of a road, the Purchaser may be required to pile residue with a log loader or by hand. Residue piles shall be a minimum of 15 feet away from any live trees. Piles shall be located and constructed as directed by the Forest Officer.
6. Systematic Harvest Unit Operations: When harvest operations are begun on a designated harvest unit, the harvest operations on that unit shall be fully completed before cutting may begin on other harvest units.

## TIMBER SALE CONTRACT

7. Acceptance of Completed Harvest Units: The Forest Officer will notify the Purchaser in writing when all contract requirements for each specified harvest unit or area have been met. After notice has been received, the Purchaser is not required to do additional work on the specified area except as provided in Section VII.A.4. FIRE KILL, INSECT INFESTATION, AND WIND THROWN.
- N. HAULING RESTRICTIONS**: The Purchaser will be required to restrict or suspend hauling during periods when the compacted road surface would be damaged, as directed by the Forest Officer. Restrictions are required when hauling would cause rutting into the subgrade, or surfacing materials would be displaced, such as during heavy rainfall or spring breakup freezing and thawing cycles
- O. LOGGING OPERATIONS SAFETY SIGNS**: Road signs warning of logging and road construction operations shall be posted 500 feet from the operations. When log hauling is in progress, warning signs shall be posted at major road junctions as directed by the Forest Officer. Warning signs must comply with specifications in the Manual on Uniform Traffic Control Devices.

*BLACKTAIL AGAIN  
TIMBER SALE VICINITY  
MAP*

**State Trust Land Vicinity Map  
Dillon Unit**

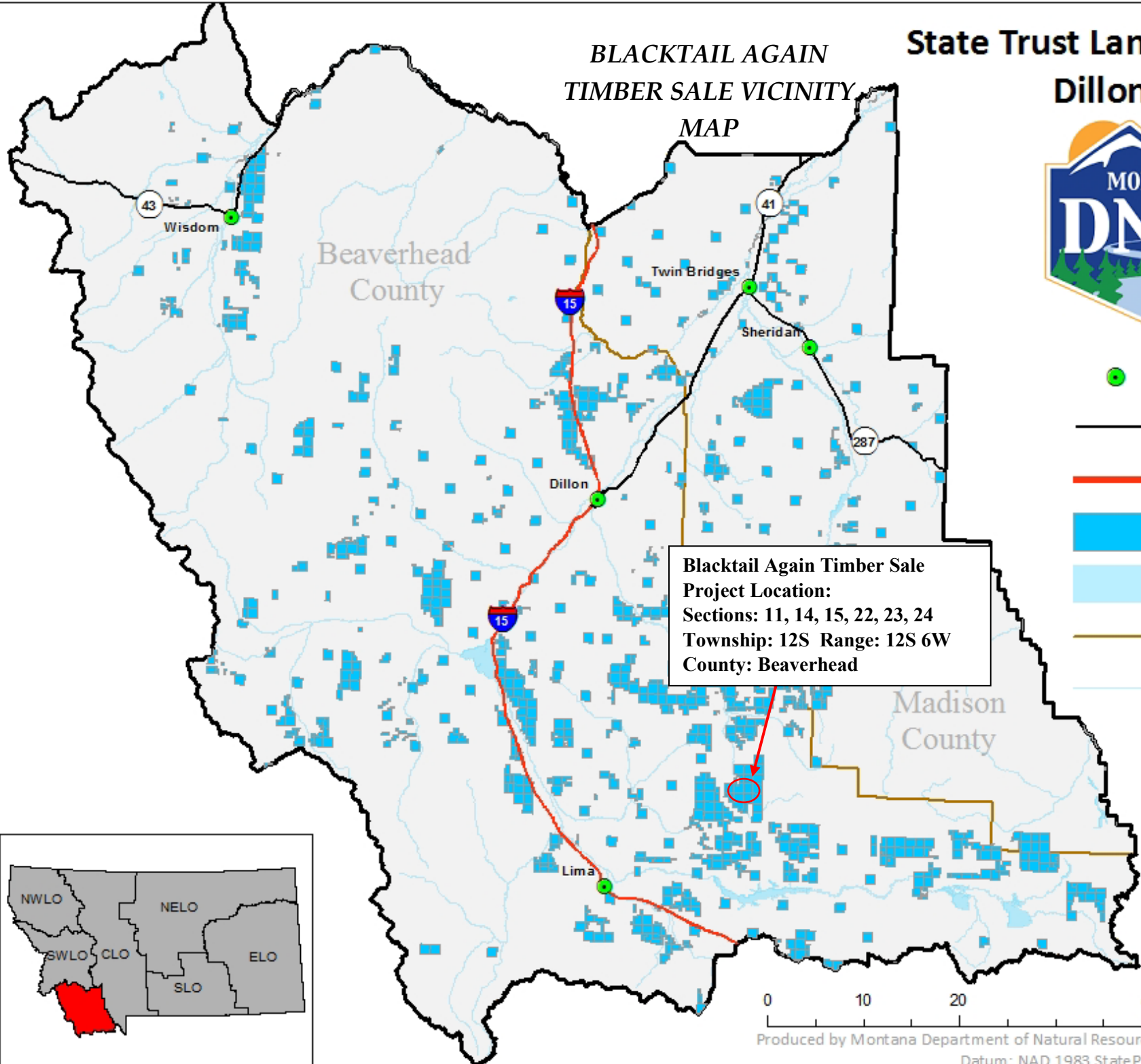

**Blacktail Again Timber Sale  
Project Location:**  
Sections: 11, 14, 15, 22, 23, 24  
Township: 12S Range: 12S 6W  
County: Beaverhead

- Towns
- Major Roads
- Interstate
- State Trust Land
- Water Bodies
- County Lines
- Rivers

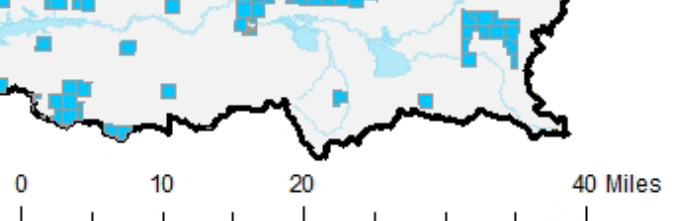
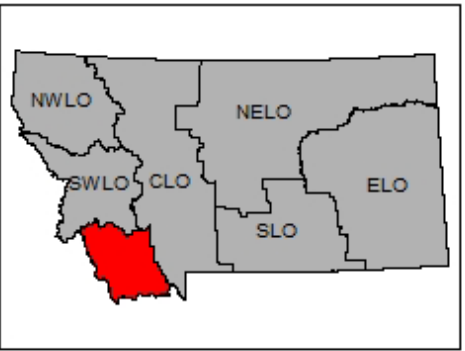

# Blacktail Again Timber Sale Harvest Map

## Attachment A

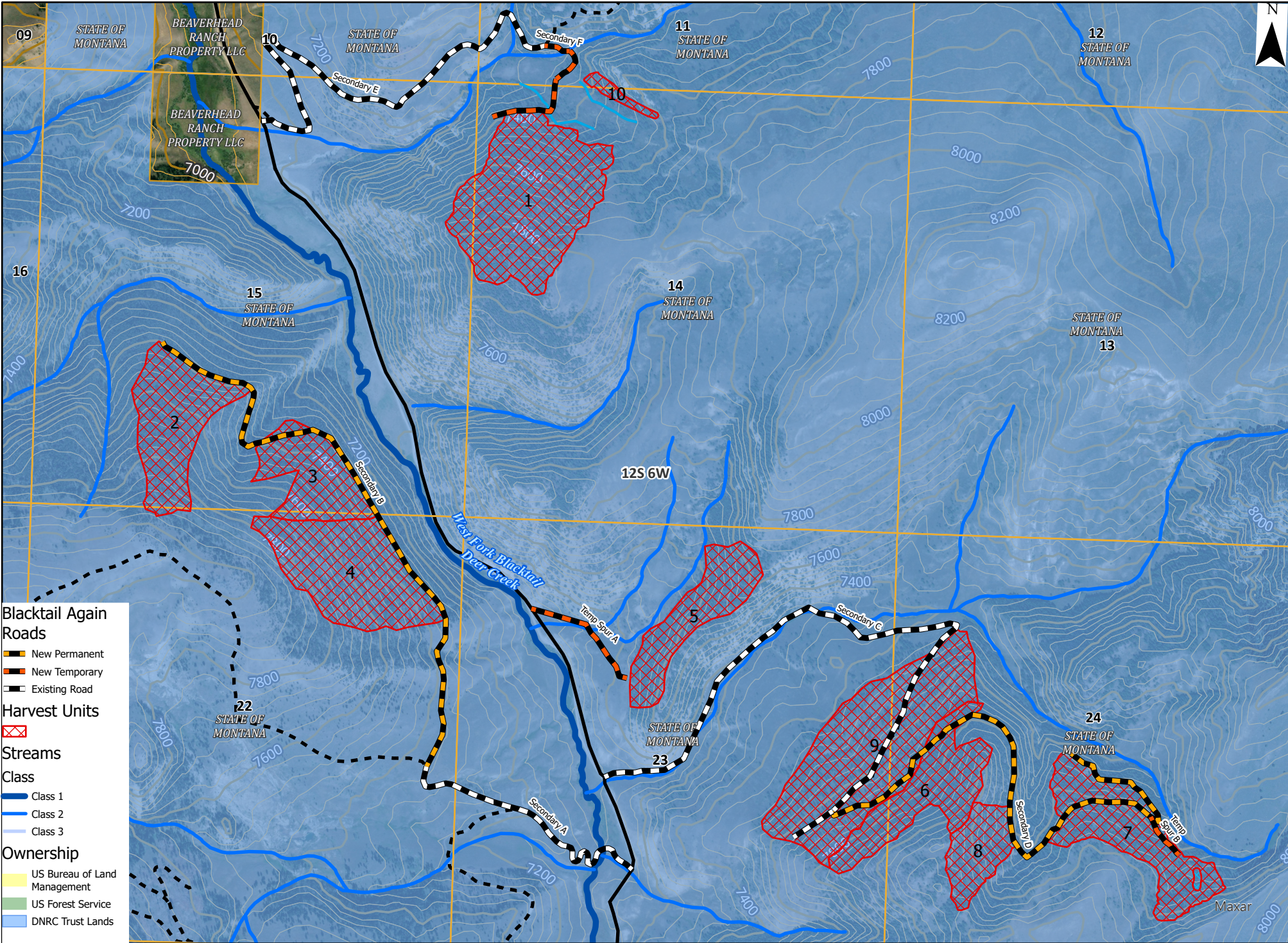

- Blacktail Again Roads**
- New Permanent
  - New Temporary
  - Existing Road
- Harvest Units**
- Harvest Unit
- Streams**
- Class
- Class 1
  - Class 2
  - Class 3
- Ownership**
- US Bureau of Land Management
  - US Forest Service
  - DNRC Trust Lands

# Blacktail Again Timber Sale - Haul Route

## Attachment A

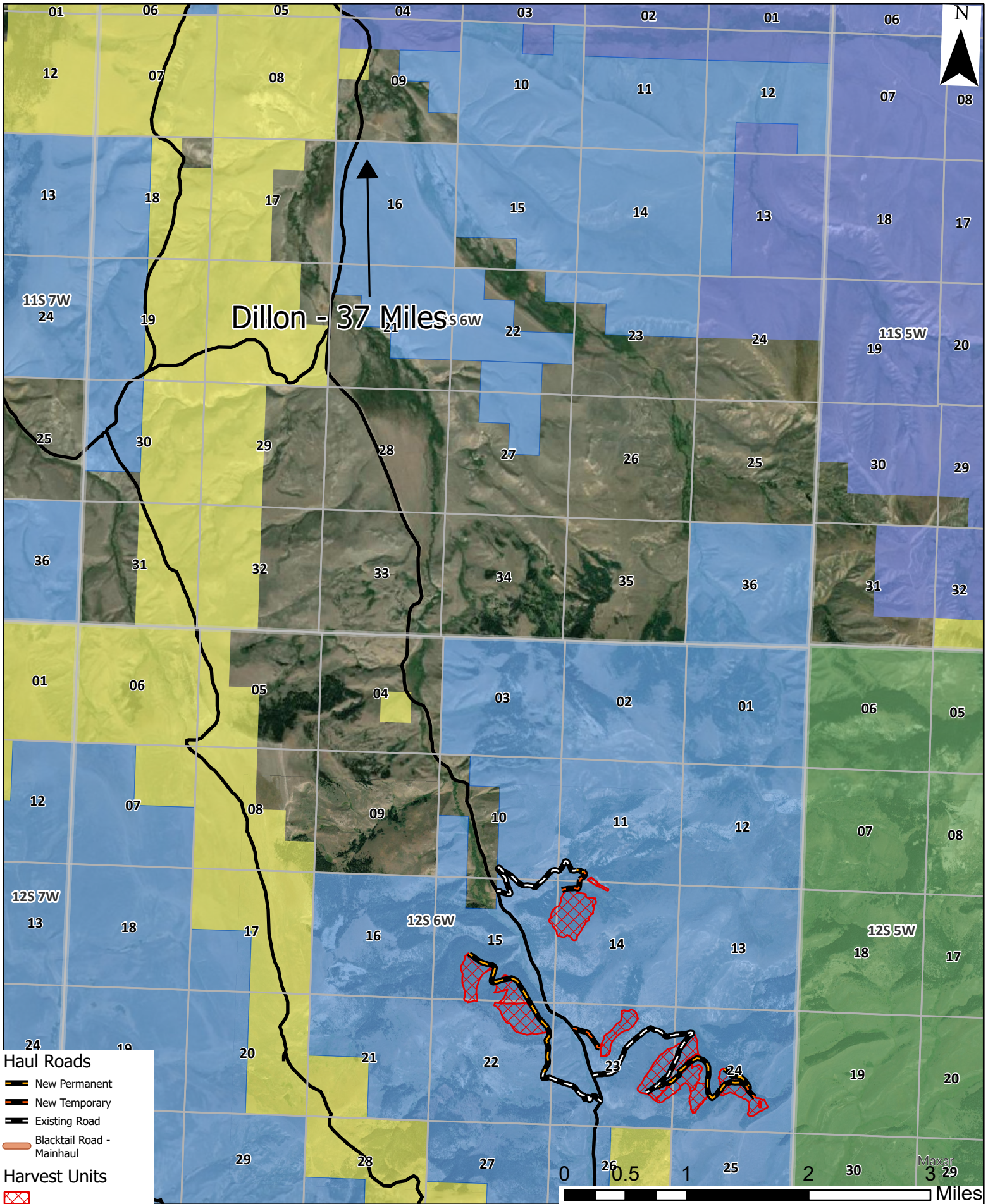

**Haul Roads**

- New Permanent
- New Temporary
- Existing Road
- Blacktail Road - Mainhaul

**Harvest Units**

- 



**STATE OF MONTANA  
TIMBER SALE CONTRACT  
ATTACHMENT B**

<b>ROAD CONSTRUCTION, IMPROVEMENT AND MAINTENANCE SPECIFICATIONS</b>	
<b>SALE NAME</b> Blacktail Again	<b>SALE NUMBER</b>

**I. CONSTRUCTION REQUIREMENTS**

- A. ROADS:** The Purchaser is required to construct the roads shown in Table B-1 per the schedules stated, as shown on the Sale Map, Attachment A, and to the specifications and drawings in Attachment B and other applicable attachments.

<b>TABLE B-1. ROAD CONSTRUCTION REQUIREMENTS</b>				
Road Name or Number	Approximate Length (Miles)	Type of Construction	Operation Period	Completion Date or Requirement
Secondary A	0.66	Maintenance	Year round as conditions allow or adequate shaping and compaction as determined by the Forest Officer.	All road maintenance and construction must be completed before harvest and hauling operations commence in the unit for which the road is used to access
Secondary B	1.44	Permanent Construction		
Secondary C	1.55	Maintenance and Reconditioning		
Secondary D	1.47	Permanent Construction		
Secondary E	1.21	Maintenance		
Secondary F	0.33	Temp Construction		
Spur A	0.30	Temporary Construction		
Spur B	0.11	Temporary Construction		

**B. ROAD CONSTRUCTION MATERIALS ESTIMATE:**

<b>TABLE B-2: MATERIALS FURNISHED AND INSTALLED BY THE PURCHASER:</b>					
The Purchaser is required to furnish the described material and install as required in Attachment B. Quantities are estimated, and the Attachment B requirements and specifications must be met regardless of the estimated amounts. All materials furnished by the Purchaser become the property of the State when installed. If, due to a minor design change, material is not installed, the material will be delivered to the nearest DNRC Unit Office and become property of the State upon delivery.					
Corrugated Metal Pipe				Other Materials	
No.	Diameter	Length	Gauge	Amount	Description
1	24	36	16	1	24 inch CMP Band
				2	18"x20' ADS Culvert
				2	ADS Band
				1	12 feet of 1 inch rebar
				1	36 feet of 4x24 inch abutment beam
Fill Material					
Yards	Type			Delivery Location	
10	Pit Run			Secondary B Draw Crossing	
10	Rock Armor			Secondary B Draw Crossing	

<b>TABLE B-2 (CONTINUED): SEED AND FERTILIZER REQUIREMENTS</b>			
The Purchaser is required to furnish certified noxious weed-free, pure live seed mixture(s) and fertilizer in the amounts shown. Total pounds mixed seed are pure live seed, corrected for germination and purity. Germination and purity tests must have been conducted within the last 12 months prior to delivery. Purchaser shall furnish documentation of germination and purity tests to the Forest Officer prior to application.			
Certified Noxious Weed-Free Seed		Fertilizer	
Pounds	Description	Pounds	Analysis (N-P-K)
140	30% Palute Orchardgrass 30% Chief Intermediate Wheatgrass 15% VNS Canada Bluegrass 15% Fawn Tall Fescue 10% Durar Hard Fescue	N/A	N/A

<b>TABLE B-2 (Continued): MATERIALS FURNISHED BY THE STATE:</b>			
The Purchaser is required to load and haul the described materials from the State source and install them as required in Attachment B.			
Amount	Description		
1	30 foot long cross laminated timber bridge. The bridge is located at the DNRC Central Land Office in Helena. The purchaser will be responsible for mobilizing the bridge.		
Fill Material			
Yards	Type	Source Location	Delivery Location
n/a	n/a	n/a	n/a



- C. MINOR CHANGES:** The Forest Officer may require minor changes in location, design or specifications of road construction, improvement or maintenance requirements. Such changes must be within the scope of Attachment B requirements, and must not result in a significant (one thousand dollars [\$1,000.00] or greater) increase or decrease in cost as agreed to by the Forest Officer and the Purchaser.
- D. ADJUSTMENT FOR CHANGE IN REQUIREMENTS:** If the State requests a change in road construction, improvement or maintenance specifications and the State in its discretion determines that the change would significantly increase the cost to the Purchaser, then the State must compensate the Purchaser. If the Purchaser requests a change in road construction, improvement or maintenance specifications and the State in its discretion determines that the change is acceptable and would significantly reduce the cost to the Purchaser, then the Purchaser must compensate the State. Compensation to the Purchaser will be in the form of stumpage credit. Compensation to the State will be in cash and will be billed as a supplement to the stumpage bill. All significant changes and compensation will be described in a contract modification.

## **II. RIGHT-OF-WAY CLEARING**

- A. CLEAR LIMIT DEFINITIONS** are shown in Section IX. SPECIFICATIONS AND DRAWINGS.
- B. CLEAR LIMIT MARKING:**
1. Clear limits for existing roads are not marked
  2. Clear limits for all new construction are marked with n/a paint dots facing into the road right-of-way.
- C. CLEARING REQUIREMENTS:**
1. Brush or trees on existing roads may be removed by sawing individual stems, cutting with a rotary brush cutter, uprooting with an excavator or other methods approved by the Forest Officer.
  2. Inside the clear limits, but outside the road prism, trees and brush less than 20 feet tall and less than 3 inches in diameter that do not interfere with visibility or slope stability may be left as directed by the Forest Officer.
  3. All merchantable timber within the clear limits on all roads to be constructed under the terms of this Contract shall be cut to the specifications in the timber sale contract and skidded to decks, or decked with an excavator, prior to earth moving.
  4. Clearing procedures shall protect residual stands, prevent incorporation of construction slash into the road prism, and protect roadside appearance outside clear limits.
  5. Grubbing will be limited to only those stumps and large roots within the road prism.

## **III. TREATMENT OF RIGHT-OF-WAY CLEARING MATERIALS**

- A. GENERAL TREATMENT REQUIREMENTS:**
1. Road construction slash more than 3 inches in diameter and 6 feet long and all concentrations of slash which would adversely affect the stability of the road shall be disposed of by the methods described in this section.
  2. Slash and debris shall not be placed in drainages, roadside ditches or heads of culverts where the flow of water may be obstructed and shall be removed if placed therein.

3. Lopping and scattering is defined as delimiting and sawing slash materials into lengths which will easily scatter to a maximum depth of 18 inches. Materials shall be scattered outside the road prism.
4. All slash to be disposed of by piling and burning shall be piled in burn bays at locations approved by the Forest Officer. Construction of piles will be of such size and at a sufficient distance from trees so that burning does not result in unnecessary damage to remaining trees. The Purchaser may be required to remove any trees damaged by burning operations at current contract rates. If burning is incomplete the residue must be disposed of as directed by the Forest Officer.

**B. SIDESLOPES OF 35% OR LESS AND EXISTING ROADS:**

1. Disposal will be by hand or machine piling for burning as directed by the Forest Officer.
2. Minor concentrations of slash or individual trees may be disposed of outside of the road prism by lopping and scattering as directed by the Forest Officer.
3. Tree stumps, large boulders and cull logs may be scattered outside the road right-of-way clear limits if approved in writing by the Forest Officer. Scattered stumps and boulders shall be placed away from trees and positioned so they will not roll.

**C. SIDESLOPES OF 35% AND GREATER:**

1. Treatment will be by excavator only, or by whole tree skidding to a decking area.
2. Where topography and timber types permit, piling for burning will be required as directed by the Forest Officer.
3. Where piling is not practical, treatment will be by windrowing at the toe of the fill. Slash will be windrowed on a trail constructed at the bottom of the right-of-way. Slash will be trampled and covered with organic surface material taken from the road prism as directed by the Forest Officer. Fill material may butt up against but not cover or bury the windrow.
4. Minor concentrations of slash or individual trees may be disposed of by lopping and scattering as directed by the Forest Officer.
5. Tree stumps, large boulders and cull logs may be scattered outside the road right-of-way clear limits if approved in writing by the Forest Officer. Scattered stumps and boulders shall be placed away from trees and positioned so they will not roll.

**IV. EXCAVATION AND EMBANKMENT OF FILL MATERIALS**

**A. EXCAVATION OF ROAD CROSS SECTION:**

1. All grubbing and clearing shall be completed prior to the beginning of any excavation.
2. Surface organic layer and ash cap (surface reddish-brown soils with low gravel content) will be bladed to the side of the road and not incorporated into fills.
3. Wasted soils and organic layer will be shaped and spread to natural contours at locations approved by the Forest Officer.
4. When excavating on tangents and when balanced section construction is indicated, the following table will be used as a guideline to determine if sufficient excavation of road solid has occurred. Tolerances for road solid will be +1.0 feet and -0.5 feet.

TABLE B-3: EXCAVATION OF ROAD SOLID			
SIDESLOPE PERCENT	ROAD WIDTH		
	12 FT.	14 FT.	16 FT.
	FEET OF ROAD SOLID		
5	8.7	10.1	11.4
10	8.8	10.2	11.5
15	8.9	10.2	11.6
20	8.3	9.5	10.8
25	7.8	8.9	10.1
30	7.6	8.9	10.1
35	7.8	9.0	10.2
40	8.1	9.2	10.6
45	8.5	9.4	11.0
50	8.8	9.8	11.6
55	9.4	10.2	12.2
60	10.1	11.7	13.3
65 & over	12.0	14.0	16.0

**B. EMBANKMENT OF FILL MATERIALS:**

1. Fill materials shall be unfrozen and free of snow and ice.
2. Fill materials shall be sorted to remove large rocks over 6 inches in diameter near the surface, which may interfere with surface blading.
3. Where possible all fill materials shall be applied in layers not to exceed 18 inches and each layer compacted with heavy equipment prior to application of the next layer.
4. If fill materials are too dry to allow compaction, the Forest Officer may require watering of layers followed by heavy equipment compaction.
5. Gravel used for surfacing shall be compacted into place using loaded dump trucks or a vibratory drum roller if specified in the Road Log.

**C. PIT DEVELOPMENT AND RECLAMATION:**

1. While the gravel pit or borrow area is open the surface of the pit shall be kept clean of noxious weeds. The Purchaser shall remove any weeds found growing at the pit by pulling, cultivating, covering with plastic, spraying, or other methods as directed by the Forest Officer.
2. At completion of use, the pit area will be reshaped to as near natural contours as possible. Backslope ratios shall not exceed 3:1. Purchaser may be required to save topsoil, recontour the pit wall, and reclaim the disturbed portion of pit. All disturbed portions of the pit shall be grass seeded and fertilized.
3. At completion of use, talus slopes shall be backsloped and reshaped as directed by the Forest Officer. Grass seeding and fertilizing are required on any disturbed areas with exposed soil.

**V. DRAINAGE STRUCTURES****A. CORRUGATED METAL PIPE:** The corrugated metal pipe required in Table B-2 will be installed as follows:

1. All pipes shall be installed with a backhoe or excavator. The exact locations shall be determined and approved by the Forest Officer after the right-of-way is brushed and cleared.
2. The excavation trench for culvert installation shall not be wider than necessary to permit satisfactory jointing and thorough tamping of the bedding material under and around the pipe.
3. The bedding surface shall be constructed to provide a firm foundation of uniform density through the entire length of the culvert and shall be slightly cambered along the centerline to correct for expected settlement.
4. Where the bedding surface is not firm at the grade established, all unstable soil under the pipe and for a width of at least one diameter on each side of the pipe shall be removed and replaced with suitable selected material. Rock encountered in the bedding foundation will be removed to at least 12 inches below the bottom of the pipe and one diameter on each side. The final bedding area shall consist of fine, compacted granular material.
5. Selected material shall be placed alongside the pipe for backfill in alternating layers not exceeding six inches in depth and thoroughly compacted by a hand held mechanical tamper (wacker packer). Special care must be taken to compact the fill thoroughly under the haunches of the pipe. Wacker packer compaction of backfill must be done for a horizontal distance on each side of the pipe equal to either one pipe diameter or to the outside limits of the trench, whichever is less. The depth of wacker packer compaction must extend at least to the top of the pipe.
6. Selected native fill material will be free from rocks and hard earth clods larger than 3 inches in size. Frozen material, sod or a high percentage of organic matter is not permitted.
7. The remainder of the fill above the top of the pipe may be compacted by tractor or rubber-tired roller. Fill is to extend above each pipe at least one-half the pipe diameter or a minimum of 12 inches, whichever is greater.
8. The pipe shall be protected by adequate fill cover before heavy equipment is permitted to cross during roadway construction.
9. Pipe that is damaged or improperly installed shall be repaired or replaced at Purchaser expense as directed by the Forest Officer.
10. The Forest Officer must be contacted two days before any culvert installation and must be present at any wet site culvert installation.
11. Riprap consisting of angular native rock of graded sizes 6 to 12 inches in diameter shall be installed to armor cuts and fills at both ends of all culverts installed in streams.
12. Energy dissipators consisting of native rock at least 24 inches in diameter with flat cross section shall be installed below culvert outlets in all perennial streams.

**B. WET SITE CULVERT INSTALLATION REQUIREMENTS:**

1. The Forest Officer and the Purchaser shall agree upon a site specific sediment and erosion control plan that meets the requirements of all attachments and permits for each wet installation prior to any construction. Sediment and erosion control features may include any or all of the following at each site:

- a. Filter Fabric Sediment Traps.
  - b. Sediment Control Fence.
  - c. Slash Filter Windrows.
  - d. Other measures as directed by Forest Officer.
2. The Forest Officer and the Purchaser shall agree upon a site specific water diversion plan for each wet installation. Diversions may include: by-pass ditches, plastic lined by-pass ditches, plastic or metal pipe by-passes or other methods as directed by the Forest Officer. Pumping with discharge back into the channel is not permitted.
  3. All wet site culvert installations require seeding of all disturbed areas with Quick Cover Mix the same day as installation is completed.
  4. Any equipment operated within the high-water level of any stream or river channel shall be free of oil and fluid leaks and shall be clean of mud. Said equipment must be inspected by the Forest Officer and approved prior to any use.
  5. Filter fabric sediment traps shall be installed prior to any construction activities on all wet culvert installations.

## **VI. ROAD MAINTENANCE**

### **A. ROAD MAINTENANCE SCHEDULE AND REQUIREMENTS:**

1. Road maintenance may be required on all native material or gravel roads designated for hauling purposes.
2. Road maintenance is defined to include all operations listed under Section VI. of Attachment B.
3. Initial maintenance of the roads shall be completed prior to use for logging and hauling.
4. The Forest Officer will determine the number, type, extent and frequency of intermediate maintenance operations. Road maintenance shall be repeated as needed to facilitate traffic and proper road drainage. The Purchaser will be advised of the time limitations to complete each maintenance project.
5. Final maintenance of the road system is required after all logging and hauling and prior to termination of the Timber Sale Contract.

### **B. SURFACE BLADING:**

1. Description: Surface blading is keeping a native or aggregate roadbed in a condition to facilitate traffic and provide proper drainage. It includes maintaining the crown or slope, shoulder, drainage dips, leadoff ditches, berms and turnouts, and provides a level of smoothness appropriate for the amount and kind of traffic served and consistent with existing surfacing.
2. Specifications:
  - a. The existing roadbeds, including turnouts, shall be bladed and shaped to reasonably conform to the designed cross section, and to eliminate ruts. Existing aggregate surfacing shall be bladed to conserve material and to prevent segregation of particle sizes. Rocks or other material remaining on the traveled way surface after final blading which are 4 inches or larger in size shall be removed from the road surface.

- b. Roadside cutslopes should not be undercut when cleaning ditches or removing road sloughs. Berms shall be removed from road shoulders when blading, except where berms are located as part of road design.
- c. Cutslopes that have been undercut may require backsloping, seeding and fertilizing.
- d. At intersections, the roadbeds at side roads shall be graded for a reasonable distance to assure proper blending of the two riding surfaces.
- e. Drainage dips and leadoff ditches shall be cleaned and graded to form their previous line and grade.
- f. Crowned roads should slope towards shoulders at least 2-5% (1/4-1/2 inch per foot road width) on native and gravel roads.
- g. At intersections where side roads enter the main road and the entering side road exceeds +3%, shallow ditching across the side road may be required to divert surface runoff and protect the main road's stability.
- h. The side-casting of road material into a stream, lake, wetland, or other body of water during road maintenance operations is prohibited in the SMZ.

**C. DITCH CLEANING:**

- 1. Description: Ditch cleaning is removing and disposing of all foreign and slough material from roadside ditches to provide an unobstructed waterway conforming reasonably to previous line, grade and cross section.
- 2. Specifications:
  - a. Slough material removed from the ditch may be blended into existing native road surface or shoulder only if it is the same material as the road surface. Slough material that is not suitable for blending should be disposed of as directed by the Forest Officer.
  - b. Live vegetation and other organic material shall be removed and disposed of as directed by the Forest Officer.
  - c. Unstable stumps, rocks, leaning trees or other debris shall be removed from the cutslope as directed by the Forest Officer.

**D. CULVERT MAINTENANCE:**

- 1. Description: Maintenance is work performed on inlets, outlets, catch basins, related channels, existing riprap, trash racks and any other facilities related to the drainage structure.
- 2. Specifications: Catch basins, outlets and energy dissipaters shall be kept functioning and cleaned of debris. Ends of culverts shall be kept straight and undamaged. Any washing alongside or underneath the culvert shall be repaired.

**E. ROADSIDE VEGETATION MAINTENANCE:**

- 1. Description: Maintenance of roadside vegetation includes removal of brush, tree growth, deadfall or other obstructions to passage, safety or visibility, as such obstructions are present or develop during the contract period.
- 2. Specifications:

- a. All trees that have fallen across the road shall be removed from the road prism unless otherwise agreed upon. Merchantable timber, if any, shall be cut in appropriate lengths and decked along the roadside in locations where traveled way width or sight distances will not be impaired.
  - b. Brush and seedling trees that encroach upon the original road clear limits shall be removed when they reduce safe sight distances. Low shrubs and brush that do not restrict sight distance but provide cover and reduce erosion shall not be removed. Brush and seedling trees removed shall be disposed of as directed by the Forest Officer.
- F. SNOWPLOWING:** If hauling occurs during the winter months, the Purchaser will be required to plow snow to the following guidelines on all State and private roads.
1. Snow should be windrowed beyond the fill shoulder line.
  2. To protect the road surface, a 1 to 4-inch cushion of snow may be left on the road.
  3. At termination of use, the road will be prepared for spring runoff by opening drainage outlets through the plowed berms and by installing a snow-berm road closure.
  4. Tracked equipment will not be used to plow snow without prior written approval from the Forest Officer.
  5. The side-casting of road material into a stream, lake, wetland, or other body of water during snow plowing operations is prohibited in the SMZ.
- G. DUST ABATEMENT:** The Purchaser may be required to perform dust abatement on any of the roads designated as part of the haul route. Any dust abatement must conform to current standards of the owner of the road.
1. If the Purchaser applies Magnesium Chloride or Calcium Chloride for dust abatement, the following specifications will be followed:
    - a. Dust abatement will be applied prior to summer hauling of logs.
    - b. Scarify road surface and grade to final grading specifications. A minimum of two inches of loose material is required on the road surface prior to applying the abatement.
    - c. The road surface will be moist to a minimum of depth of two inches or watered uniformly to moisten the road. If the road is watered, it will be done twelve to twenty-four hours prior to application of the abatement.
    - d. The abatement will be applied at the rate of 0.25 gallons Magnesium Chloride per square yard or 0.20 gallons Calcium Chloride per square yard, followed immediately by another application at the same rate, for a total of 0.5 gallons Magnesium Chloride per square yard or 0.4 gallons Calcium Chloride per square yard.
    - e. Chemical abatement will not be applied for 50 feet on either side of any stream crossing.
    - f. Additional treatments using water may be required if deemed necessary by the Forest Officer.
- H. NOXIOUS WEED MANAGEMENT:** The Purchaser may be required to perform noxious weed management on any of the roads designated as part of the haul route and on landings. Noxious weed management may include grass seeding, equipment washing and herbicide spraying.
1. Grass seeding, if required, is shown in Section IX, GRASS SEEDING SPECIFICATIONS.

2. All road construction equipment and equipment used in off-road logging activity must be pressure-washed by the Purchaser and inspected by the Forest Officer prior to entering the sale area. This cleaning will remove all dirt, plant parts, and material that may carry noxious weed seeds into the sale area. Other equipment and vehicles entering and leaving the sale area shall be cleaned prior to start up and kept reasonably clean during the course of operations. All subsequent move-ins of logging and construction equipment shall be treated the same as the initial move-in.
3. If spraying is required in Attachment B, it shall be done by a commercial applicator licensed by the State of Montana or by personnel under the direct supervision of the licensed applicator. All herbicide applications shall follow EPA label requirements. Any weed control must comply with the current standards of the County Weed Board and as directed by the Forest Officer.

## **VII. ADDITIONAL REQUIREMENTS**

- A. TEMPORARY SPUR ROAD SPECIFICATIONS:** Temporary spur roads are defined as any roads constructed by the Purchaser to access a harvest unit or landing which is not an existing road and may not be shown as a required road to be constructed in Table B-1. All temporary roads will be constructed to the following specifications:
1. Forest Officer shall approve the location prior to any construction.
  2. Clearing and excavation shall be kept to the absolute minimum for safe truck hauling and to prevent erosion and water quality impacts. Some sidehill excavation, minor through cuts, ditching and turnpiking may be required.
  3. Temporary culverts may be required at ditch crossings, wet areas or other locations as directed by the Forest Officer.
  4. Temporary erosion control measures may be required to meet BMP standards on the road and/or the landing area while being used.
  5. At the completion of use the road shall be shaped back to natural contours, temporary culverts removed, erosion control measures installed, the disturbed areas grass seeded and the access closed to all vehicular traffic. The Forest Officer may require scarification or ripping of compacted landings and temporary spur roads.
- B. GATES ON PRIVATE ROAD EASEMENTS:** When using private road easements to access the timber sale area, any gate encountered on private land will be left as prescribed by the easement grantor.
- C. GRID ROLLING ROAD PRISMS:** Grid rolling the road prisms is required on Roads N/A. Grid rolling is required on the total length of each road.
- D. TRAFFIC CONTROL AND WARNING SIGN SPECIFICATIONS:**
1. The Purchaser shall furnish, erect, and maintain all necessary barricades, suitable and sufficient lights, danger signals, signs, and other traffic control devices, and shall take all necessary precautions for the protection of the work and safety of the public. Suitable warning signs shall be provided to properly control and direct traffic as requested by the Forest Officer.
  2. All road barricades, warning signs, lights, temporary signals, flagger and pilot car operations and equipment, and other protective devices, shall conform with the specifications in the Manual on Uniform Traffic Control Devices (MUTCD).



## VIII. ROAD LOG AND SITE DESCRIPTIONS

	<b>Secondary A - Maintenance</b>				
0.00	Maintain adequate running surface and recondition existing drainage features to maintain functionality following harvest operations.	blading		0.66	miles
0.32	Approaching steep grade. Install 4 water bars post operations as directed by Forest Officer.	Water bar		4	each
0.66	End Maintenance				
	<b>Secondary B - New Permanent Construction</b>				
0.00	Veer right from Secondary A. Begin new construction. The road shall be built 12-foot wide, to a permanent standard with drainage features installed in accordance with BMP standards for moderately erosive soils. Center line is flagged.	construction	common	1.44	miles
1.03	Entering draw crossing.				
1.05	Install 24" x 36" CMP. Drift approximately 10 feet of fill over CMP to facilitate drainage away from draw. Fill slope ratio should be 1:1	CMP	24"	36	feet
		CMP band	24"	1	
	Bed CMP in pit run.	gravel	pit run	10	cu. yds.
	Armor CMP inlet and outlet	rock armor	18"	10	cu. yds.
	Drift approximately 4 feet of fill over CMP to facilitate drainage away from draw. Fill slope ratio should be 3/4:1. Maintain a 50 foot radius and 16 ft road width through draw crossing.	earthwork		6	hours
	Entering wet area. Begin inboard ditch construction for approximately 200 ft to provide drainage into	earthwork		3	hours
1.08	Approaching steep side slope for next 400 ft. Excavate 10 feet of solid road.				
1.44	End Construction				
	<b>Secondary C - Maintenance and Reconditioning</b>				
0.00	Maintain adequate running surface and recondition existing drainage features to maintain functionality following harvest operations.	blading		1.03	miles

**ATTACHMENT B**

0.68	Class I Stream Crossing. Install 30 foot CLT bridge supplied by the State. Channel may need to be dewatered if required by 124 permit	bridge		1	each
	install 4"x24"X18' abutment beams	abutment beams		36	feet
	Stake each abutment beam with one inch rebar	rebar		12	feet
	Remove CLT following all hauling operations and final road maintenance. Reshape portions of disturbed stream bank and pull fill back to a 2:1 ratio.	earthwork		6	hours
1.03	Transition to road surface reconditioning	Reconditioning		0.65	miles
1.56	Junction with Secondary D				
1.55	End Maintenance and Reconditioning				
	<b>Secondary D - New Permanent Construction</b>				
0.00	Leave Secondary C. Begin constructing switchback with a 50 foot radius with a 20 foot road width through the switchback. The road shall be built 12-feet wide, to a permanent standard with drainage features installed in accordance with BMP standards for moderately erosive soils. Center line is flagged.	construction	common	1.49	miles
0.46	Approaching steep side slope for next 1,000 ft. Excavate 10 feet of solid road.				
0.84	Enter dry draw crossing. Drift approximately 5 ft of fill into draw to facilitate drainage away from draw. Fill slope ratio should be 3/4:1. Maintain 16 ft road width through crossing	earthwork		3	hours
1.19	Junction with spur B				
1.21	Begin constructing switchback with a 50 foot radius with a 20 foot road width throughout the switchback				
1.47	End Construction				
	<b>Secondary E - Maintenance</b>				
0.00	Maintain adequate running surface and recondition existing drainage features to maintain functionality following harvest operations.	blading		1.27	miles
0.76	Approaching curve with steep out slope. The purchaser may drift fill from road cut slope and inside running surface				

1.12	Draw crossing with functioning cmp. No work required.				
1.21	Junction with Secondary F. End Maintenance				
	<b>Secondary F - Temporary Construction</b>				
0.00	Veer right from Secondary E. Begin new construction. The road shall be built 12-feet wide, to a permanent standard with drainage features installed in accordance with BMP standards for moderately erosive soils. Center line is flagged.				
	Water bars will be installed from stream crossing at 0.22 to 0.00 to provide long-term cross drainage and must be built to deter motor vehicle traffic post operations.	water bars		6	each
0.02	Install drain dip				
0.05	Install drain dip				
0.06	Class I Stream Crossing. Install 30 foot CLT bridge supplied by the State. Channel may need to be dewatered if required by 124 permit	bridge		1	each
	Install 4"x24"X18' abutment beams	abutment beams		36	feet
	Stake each abutment beam with one inch rebar	rebar		12	feet
	Install 18"x20' ADS culvert in side channel. ADS will be bedded in approach to bridge crossing.	earthwork		4	hours
		ADS		20	feet
		ADS Band		1	each
	Remove CLT and ADS pipe following all hauling operations and final road maintenance. Reshape portions of disturbed stream bank and remove all fill from SMZ. Banks should be reshaped to 2:1 ratio	earthwork		6	hours
0.07	Install drain dip				
0.22	Class 3 stream crossing install 18"x20' ADS pipe. Remove pipe following operations and reshape banks to 2:1 ratio. Burm removed fill to deter vehicle traffic	earthwork		6	hours
		ADS		20	feet
		ADS band		1	each
0.33	End construction				
	<b>Spur A- Temporary Construction</b>				

0.00	Veer right from Secondary E. Begin new construction. The road shall be built 12-foot wide, to a temporary standard with drainage features installed in accordance with BMP standards for moderately erosive soils. Center line is flagged.	construction		0.33	miles
	Road prism will be obliterated following harvest and haul operations	earthwork		0.33	miles
0.15	Dry draw crossing. Install drive through drain dip				
0.3	End construction				
	<b>Spur B- Temporary Construction</b>				
0.00	Veer right from secondary D. Begin new construction. The road shall be built 12-foot wide, to a temporary standard with drainage features installed in accordance with BMP standards for moderately erosive soils. Center line is flagged.	construction		0.11	miles
	Road prism will be moderately slashed in following operations	closure		4	hours
0.11	End construction				

**IX. SPECIFICATIONS AND DRAWINGS**

**A. REQUIREMENTS:** Any construction requirements or structures shown in the Timber Sale Contract or Attachment B shall be constructed and installed by the Purchaser to specifications in this section. Structures shall be constructed at locations shown in the Road Log and as specified or staked by the Forest Officer.

**B. SPECIFICATIONS:**

- Road Construction Fabric: When road construction fabric is required the following specifications shall be met: minimum twenty mills thick with minimum trapezoid tear strength (ASTMD-1117-80) of 110 and mullen burst strength (ASTMD-3786-80) of minimum 375 psi; (e.g. Mirafi 500x or AMOCO 200208).

**C. SPECIFICATION TABLES AND DRAWINGS:**

- GENERAL SPECIFICATIONS  
 CLEAR LIMITS AND TYPICAL CROSS SECTIONS  
 CLEAR LIMIT DEFINITIONS FOR EXISTING ROADS  
 STANDARD DRAIN DIP FOR SINGLE LANE ROAD  
 CULVERT INSTALLATION REQUIREMENTS  
 STREAM CROSSING & WET SITE CULVERT INSTALLATION  
 HIGHWAY SAFETY SIGNS  
 WARNING SIGN SPECIFICATIONS

BRIDGE - TEMP CLT DETAIL  
BRIDGE – TEMP CLT INSTALLATION  
BRIDGE SITE REHABILITATION  
SWITCHBACK REQUIREMENTS & SPECIFICATIONS

<b>GENERAL SPECIFICATIONS</b>	
<p style="text-align: center;"><b>ALIGNMENT</b></p> <p>Minimum Curve Radius:</p> <p>Switchbacks: 50 Feet</p> <p>Curves: As marked on the ground</p>	<p style="text-align: center;"><b>CUT SLOPE RATIO</b></p> <p>Common excavation: 1:1                      Angular Rock: 3/4:1                      Solid Rock: 1/4:1</p> <p>Maximum tolerance: plus 15%                      minus 0%</p>
<p style="text-align: center;"><b>ROAD GRADE MAXIMUM</b></p> <p>Favorable: 12%</p> <p>Adverse: 8%</p> <p>Grades as shown in the Road Log</p>	<p style="text-align: center;"><b>FILL SLOPE RATIO</b></p> <p>Common material: 1-1/2:1                      Angular rock: 1-1/3:1</p> <p>Maximum tolerance: plus 15%                      minus 0%</p>
<p style="text-align: center;"><b>DITCHES</b></p> <p>Width: 3 feet</p> <p>Depth: 1 foot</p> <p>Located as shown in the Road Log or as directed by the Forest Officer</p>	<p style="text-align: center;"><b>TURNOUTS</b></p> <p>Length: 75 feet</p> <p>Width: 7 feet</p> <p>Located by Purchaser and approved by the Forest Officer. Spacing will be intervisible as topography allows.</p>
<p style="text-align: center;"><b>USABLE ROAD SURFACE</b></p> <p>Tangents: 14 feet</p> <p>Curves: 16 feet (radius over 75 feet)                      20 feet (radius under 75 feet)</p> <p>Switchbacks: 22 feet</p> <p>Slough widening: Tangents: 1 foot                      (in addition to usable road surface)                      Curves and all fills over 6 feet height: 2 feet.</p>	<p style="text-align: center;"><b>TURNAROUNDS</b></p> <p>Dimensions: large enough to safely turn around a long wheel base 2-wheel-drive pickup.</p> <p>Location: at or near the end of all dead end roads as approved by the Forest Officer.</p>

**GRASS SEEDING SPECIFICATIONS**

**A. SEED REQUIREMENTS:** The Purchaser shall furnish certified noxious weed-free, pure live seed mixture(s) and fertilizer in the amounts shown in Table B-2. Total pounds mixed seed is pure live seed, corrected for germination and purity. Germination and purity tests must have been conducted within the last 6 months prior to delivery. Purchaser shall furnish documentation of germination and purity tests to the Forest Officer prior to application.

**B. APPLICATION REQUIREMENTS:NA**

<b>GRAVEL AND ROCK SPECIFICATIONS</b>	
<b>Material</b>	<b>Specifications</b>
3/4" minus crushed gravel	Crushed gravel. Well graded. Fine fraction (minus 200 sieve) not to exceed 15%
Pit run gravel	Native gravel, well graded, with binder, compactable and not containing any rocks over 4" diameter.
Drain rock	1"- 3" diameter, screened clean rock.
<p><b>General Large Rock Requirements</b></p> <p>Stone shall be hard, durable, angular in shape, resistant to weathering and weather action, and free from overburden, soil, and organic matter. Stone must be hard enough so pieces do not fracture or break during the loading, hauling, or placement activities. Neither breadth nor thickness of stone shall be less than one-third its length. Rounded stone or boulders from a streambed will not be accepted unless authorized by the State.</p>	
Rock armor	Large rock with most sizes ranging from 6" to 12" diameter, used to armor fill slopes and catch basins.
Talus rock	Large rock of variable sizes used as load-bearing fill or drainage rock in soft areas or French drains, as approved by Forest Officer.
Energy dissipators	Large rock 18-24" diameter placed in streams at culvert outlets.

# SPECIFICATION DRAWINGS

## Clear Limits and Typical Cross Sections

CLEARTPK.WPG

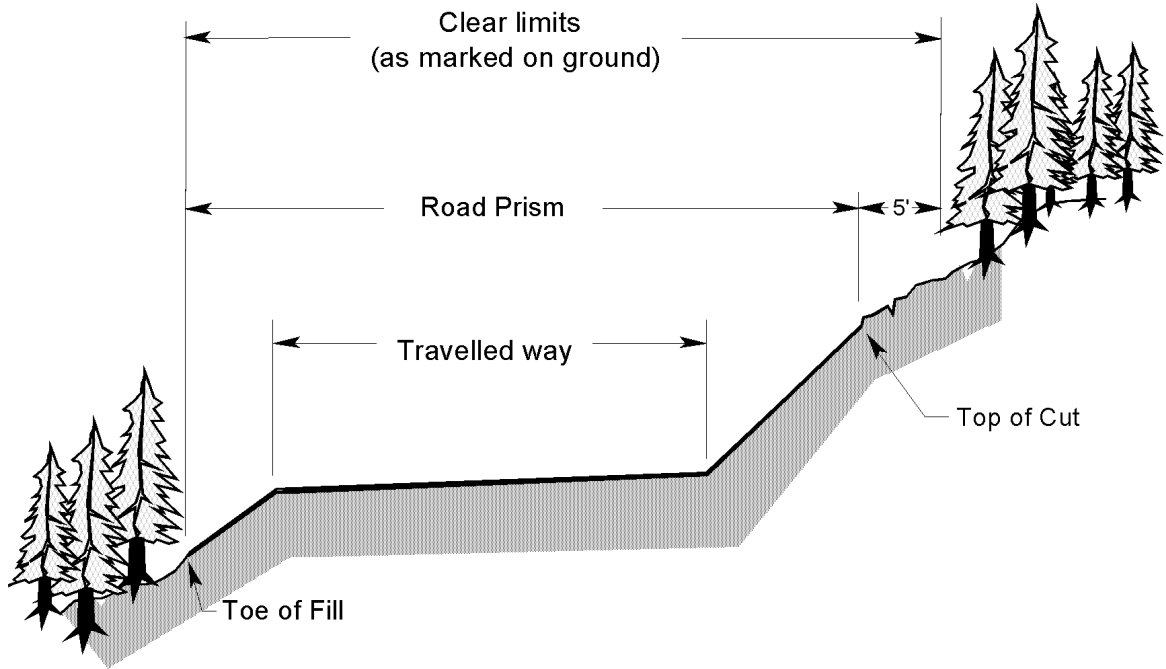

Figure I: Clear limits for New Construction

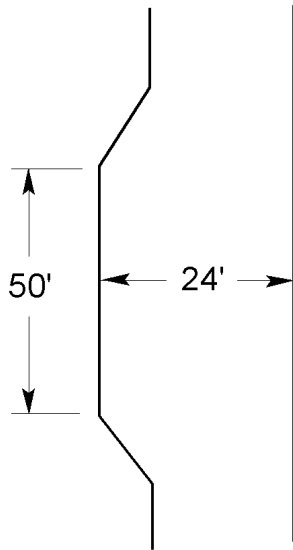

Figure II:  
Typical turn out  
construction

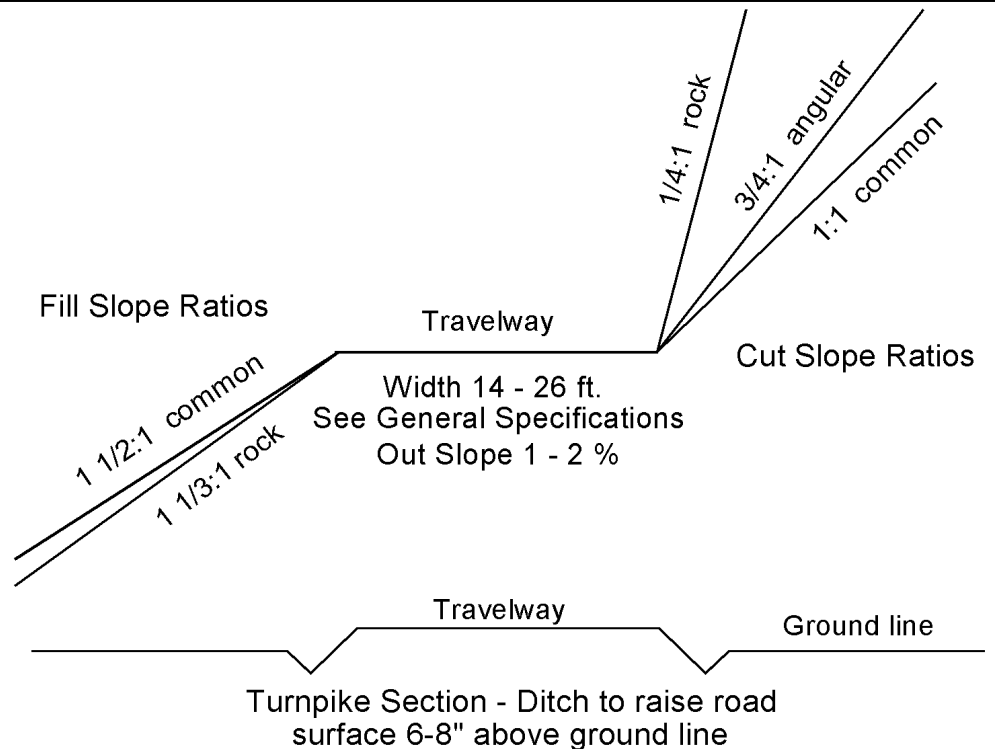
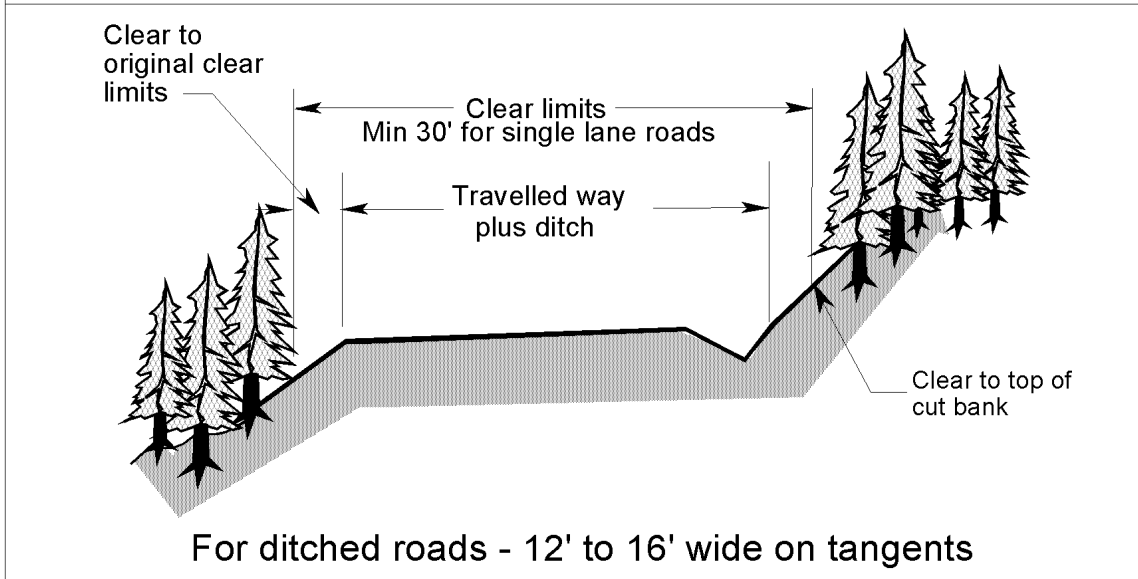
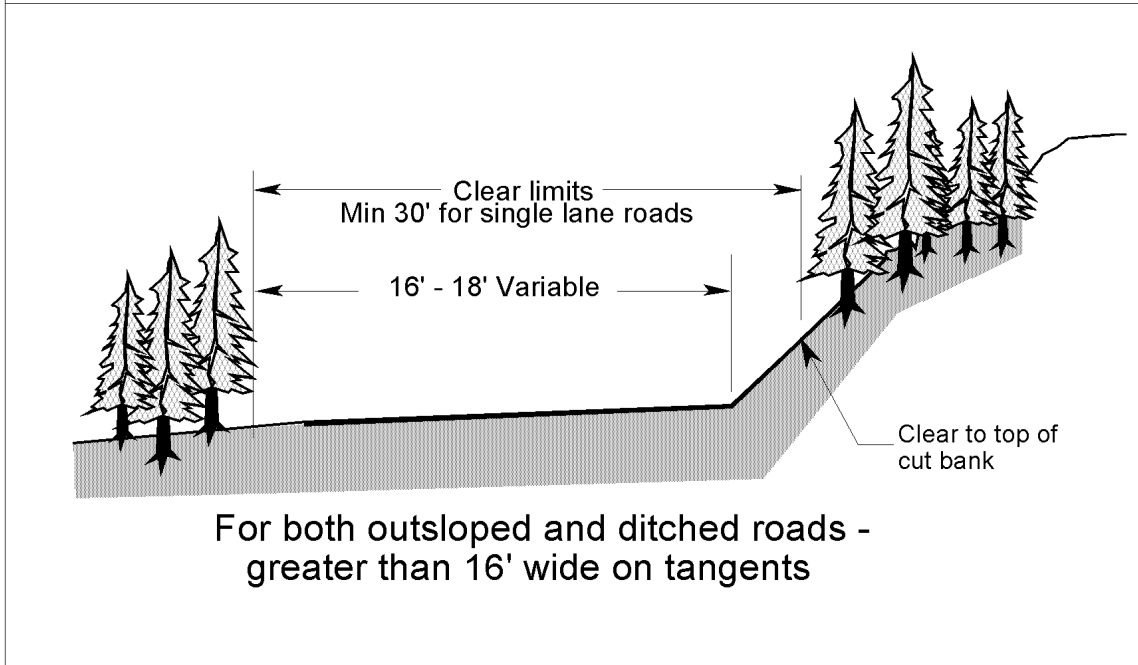
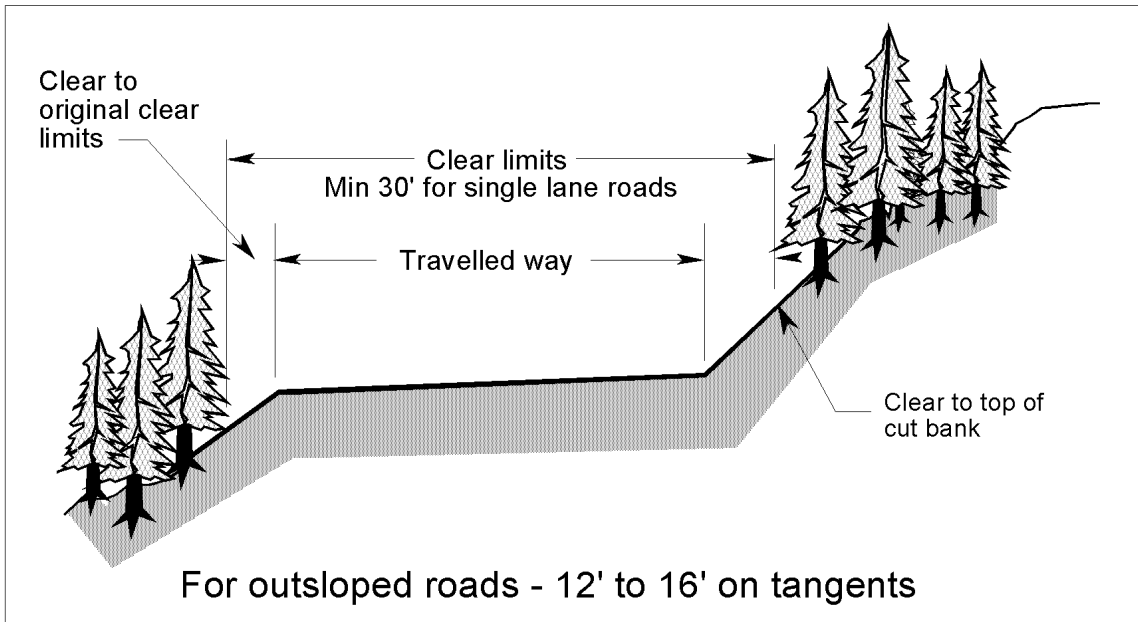

Figure III: Typical Cross Sections



# CLEAR LIMIT DEFINITIONS FOR EXISTING ROADS



# STANDARD DRAIN DIP FOR SINGLE LANE ROAD

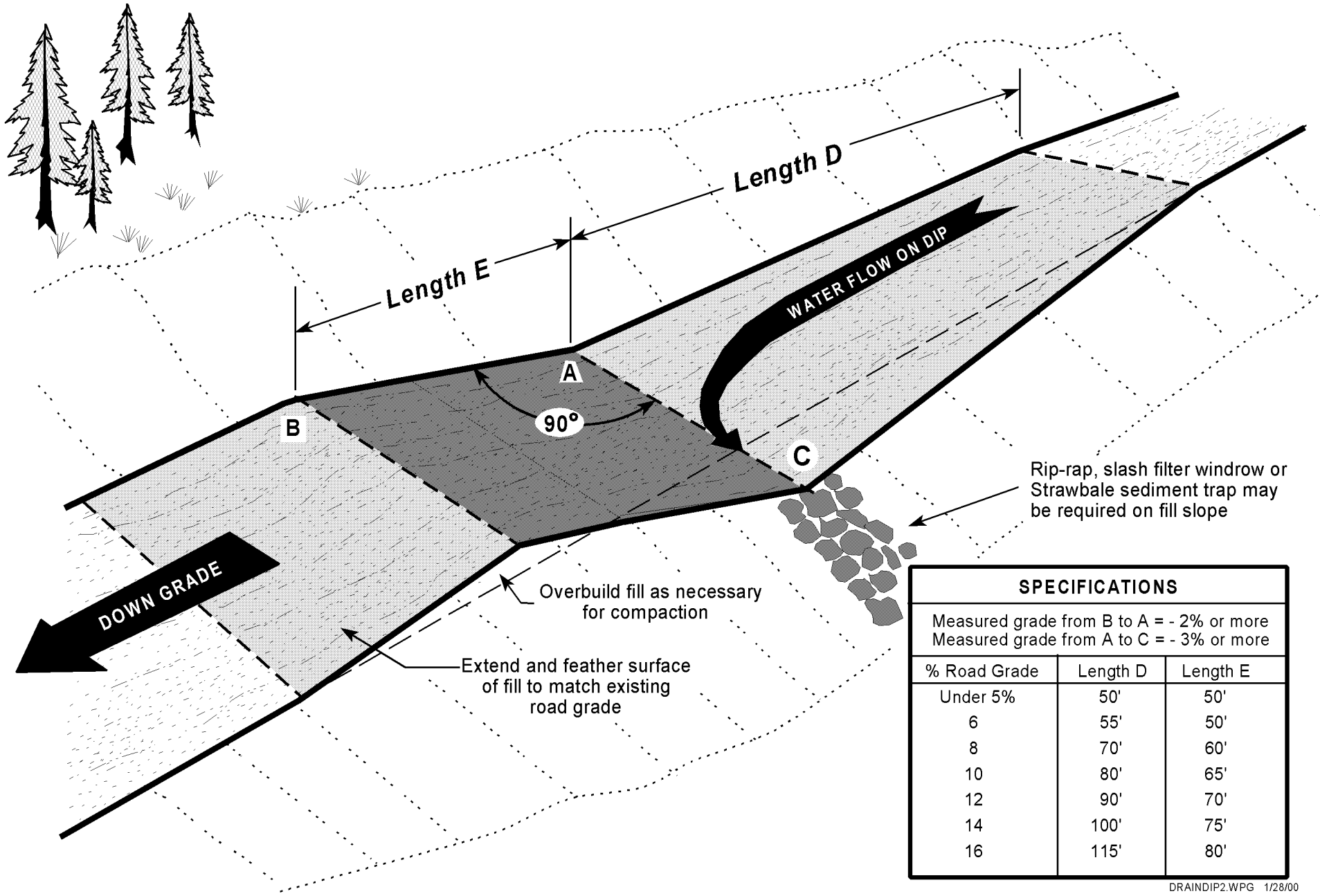

SPECIFICATIONS		
Measured grade from B to A = - 2% or more		
Measured grade from A to C = - 3% or more		
% Road Grade	Length D	Length E
Under 5%	50'	50'
6	55'	50'
8	70'	60'
10	80'	65'
12	90'	70'
14	100'	75'
16	115'	80'

# CULVERT REQUIREMENTS

- ▶ Exact locations for pipes shall be determined by the Forest Officer after right of way has been cleared.
- ▶ Backfill shall be select, sorted material. Gravel may be required in road log. If native backfill is used, rocks over 3 inches diameter, organic or frozen materials are not permitted.
- ▶ Pipe shall be protected by adequate fill before equipment is allowed to cross.
- ▶ Pipe that is damaged or improperly installed shall be repaired or replaced at purchaser's expense.
- ▶ The Forest Officer must be contacted two days before any culvert installation and must be present for any wet site culvert installation.
- ▶ Wet site installations will have additional requirements for timing, erosion control and management.

## Installation Requirements

All pipes shall be installed with a backhoe or excavator. The excavated trench shall only be wide enough to allow satisfactory joining and thorough compaction of the bedding material around the pipe.

Minimum fill depth over top of pipe on uphill edge of road for pipes less than 36" diameter is 12" or 1/2 pipe diameter, whichever is greater. Minimum fill for larger pipes is 18".

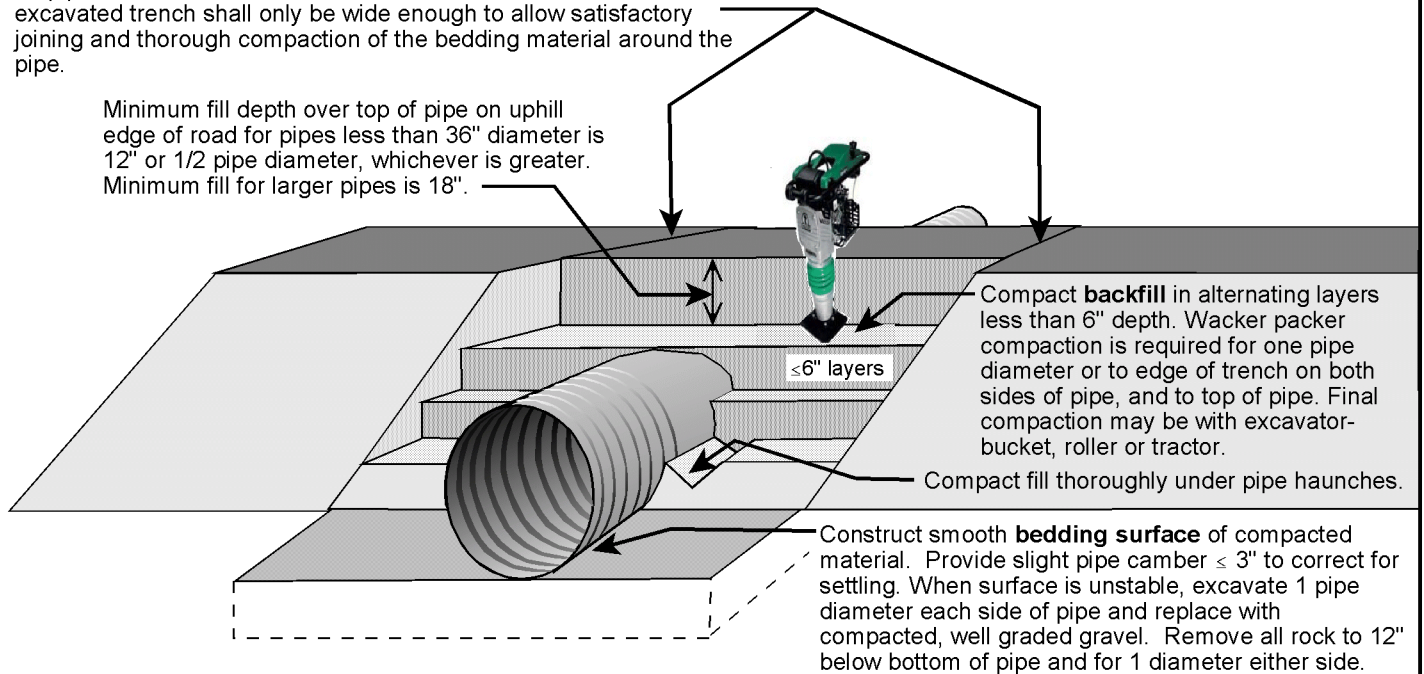

## Site Requirements

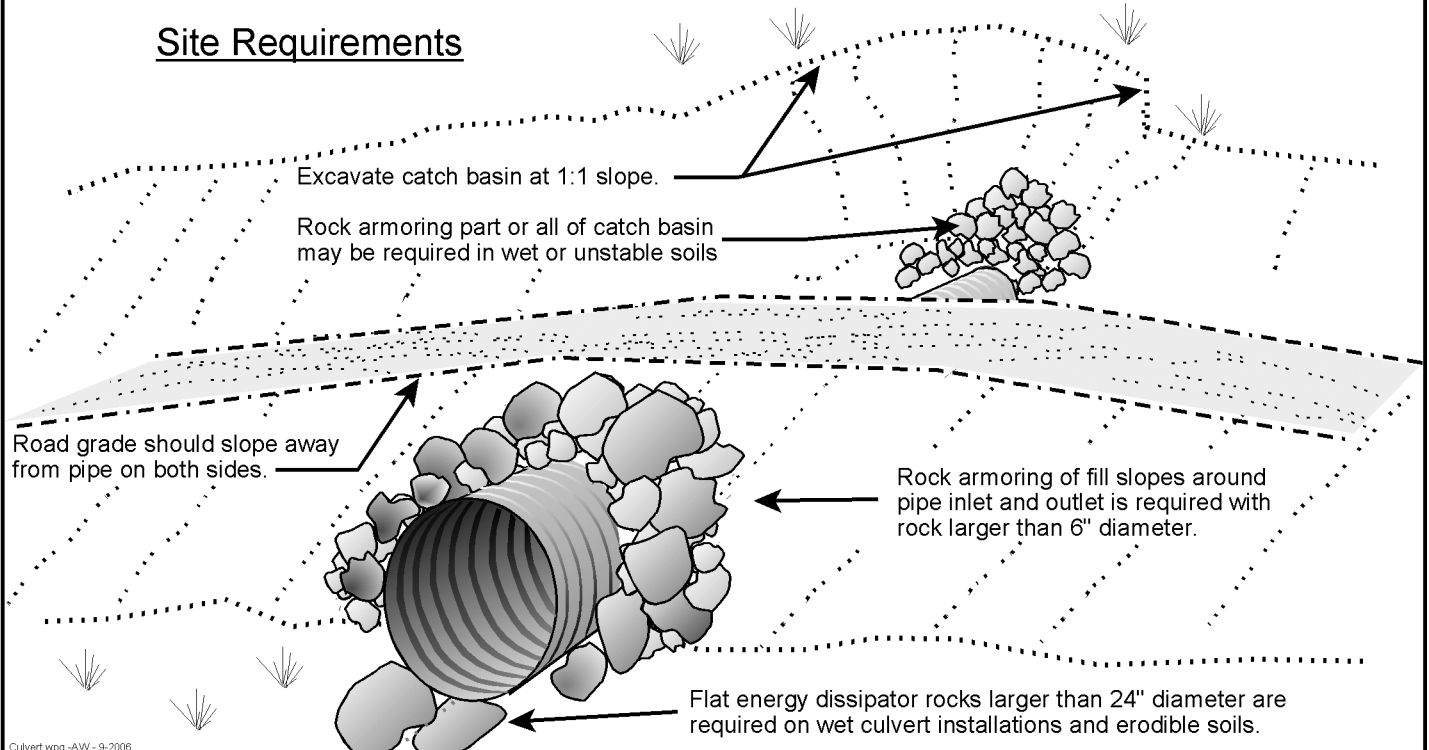

# TYPICAL STREAM CROSSING OR WET SITE CULVERT INSTALLATION

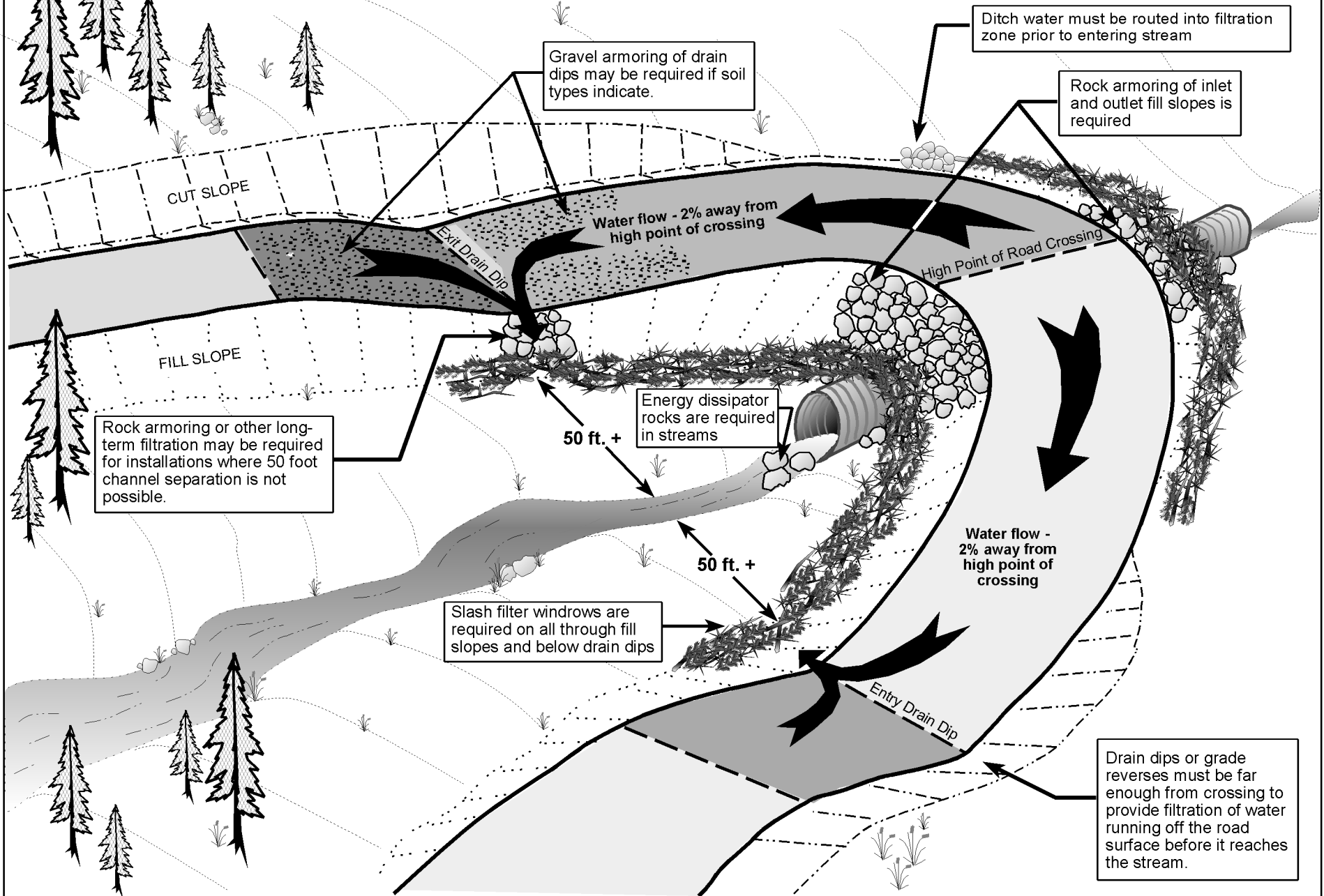

# HIGHWAY SAFETY SIGNS

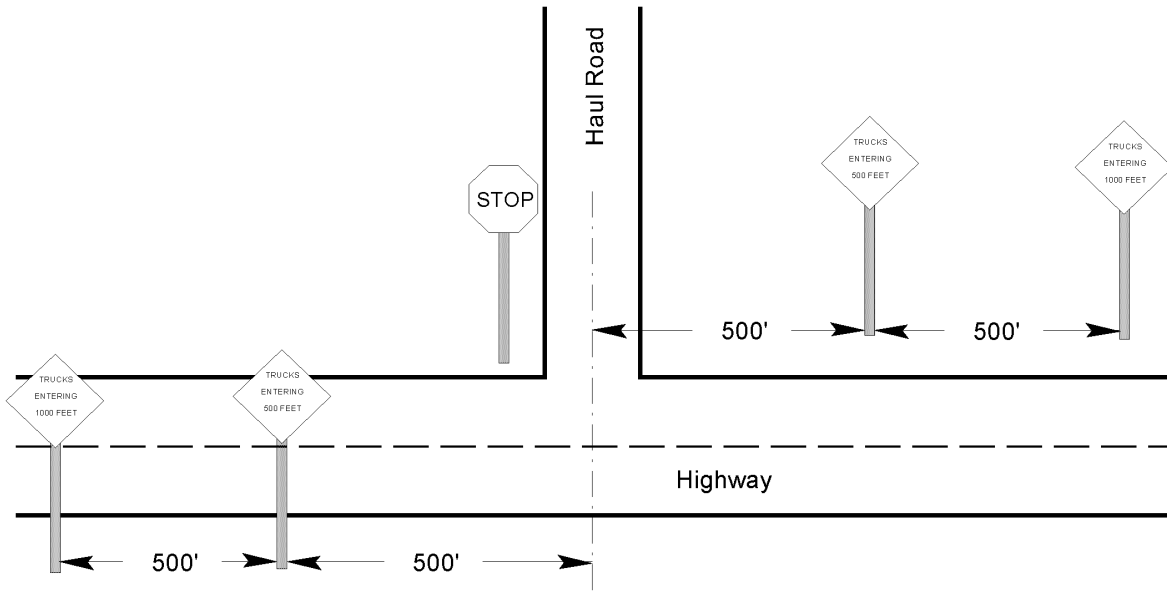

## Materials Required

- 1 each 4"x4"x10' full pressure treated wood post.
- 4 each 4"x4"x14' full pressure treated wood post.
- 1 each 30"x30" STOP sign, aluminum, octagon, white letters on red.
- 2 each 36"x36" TRUCKS ENTERING 500' sign, aluminum, diamond, black letters on orange, center hinged.
- 2 each 36"x36" TRUCKS ENTERING 1000' sign, aluminum, diamond, black letters on orange, center hinged.
- Mounting hardware as required.

## Specifications

1. All signs shall have reflectorized background and shall meet all specifications as per Manual on Uniform Traffic Control Devices.
2. All signs shall be new condition.
3. Bottom of sign shall be 5' vertical as measured from the roadway surface.
4. Lateral clearance of "TRUCKS ENTERING" signs shall be 10' as measured from the edge of pavement to the edge of sign.

# Warning Sign Specifications

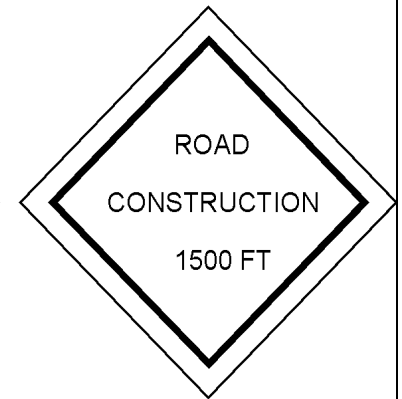
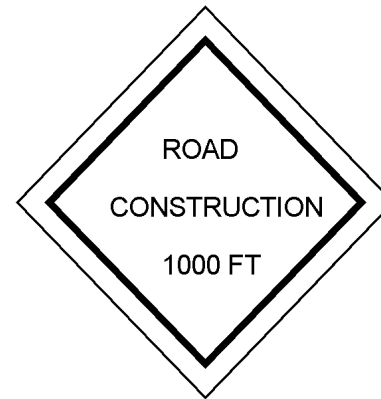
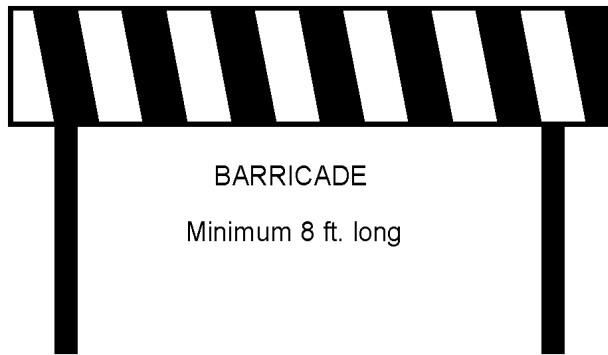
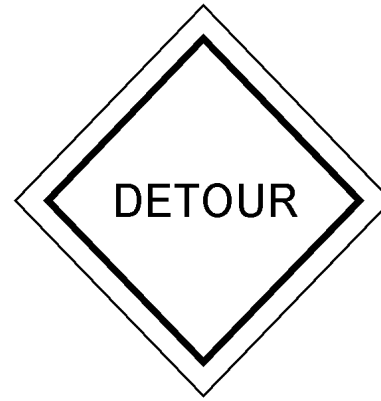

Size: 30"x 30"  
Shape: Diamond  
Color: Diamond: Orange and Black. Barricade: Red and Silver  
Lettering: Minimum 4 inch letters. Standard Alphabet Series C. 1/2 inch Border.  
Reflective Background Required  
Mounting: Posts or portable sign stands, clearly visible to drivers. Do not mount on trees.

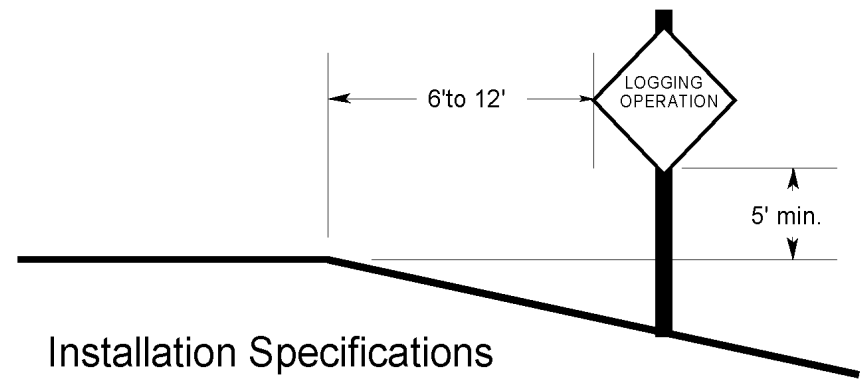

# Typical Stream Crossing Using Temporary CLT Bridge

## General specification for CLT use:

- a) Installation is limited to 6 consecutive months
- b) Maximum crossing speed is 10 mph
- c) Abutments should be set as far as possible from stream bank
- d) Maximum free span for 7 ply bridge is 15 feet
- e) Standard CLT is 15.5 feet wide
- f) Running plank must be at least 40" wide on each side

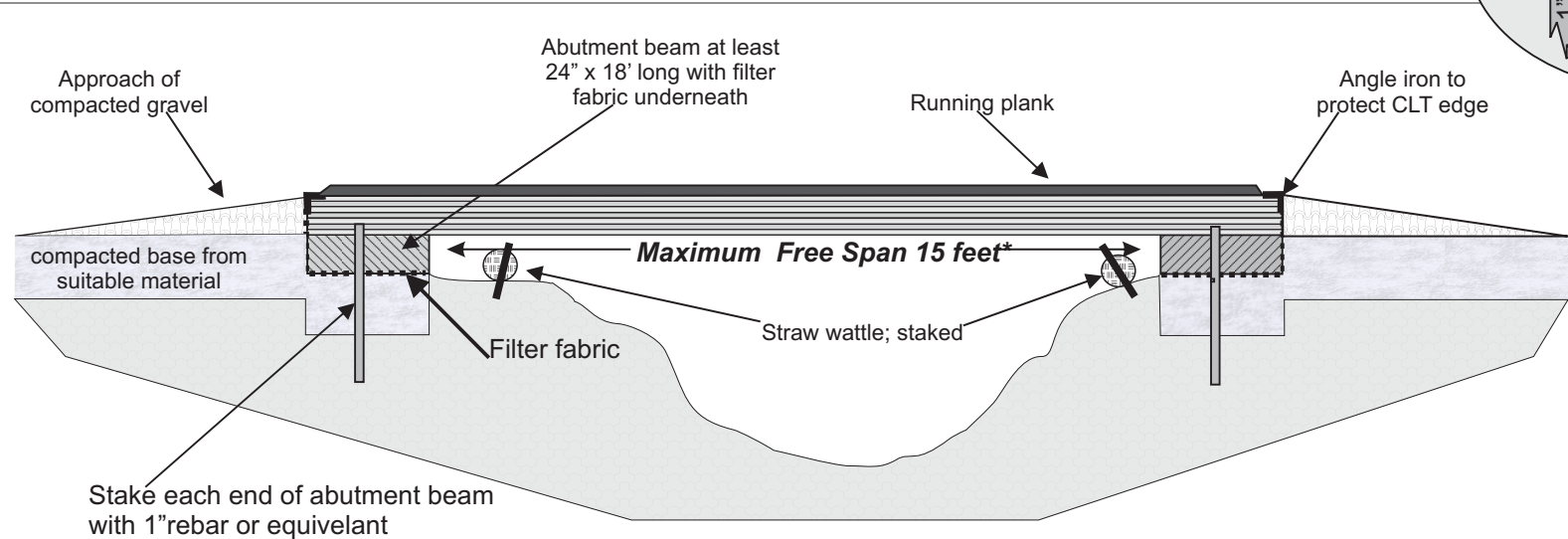
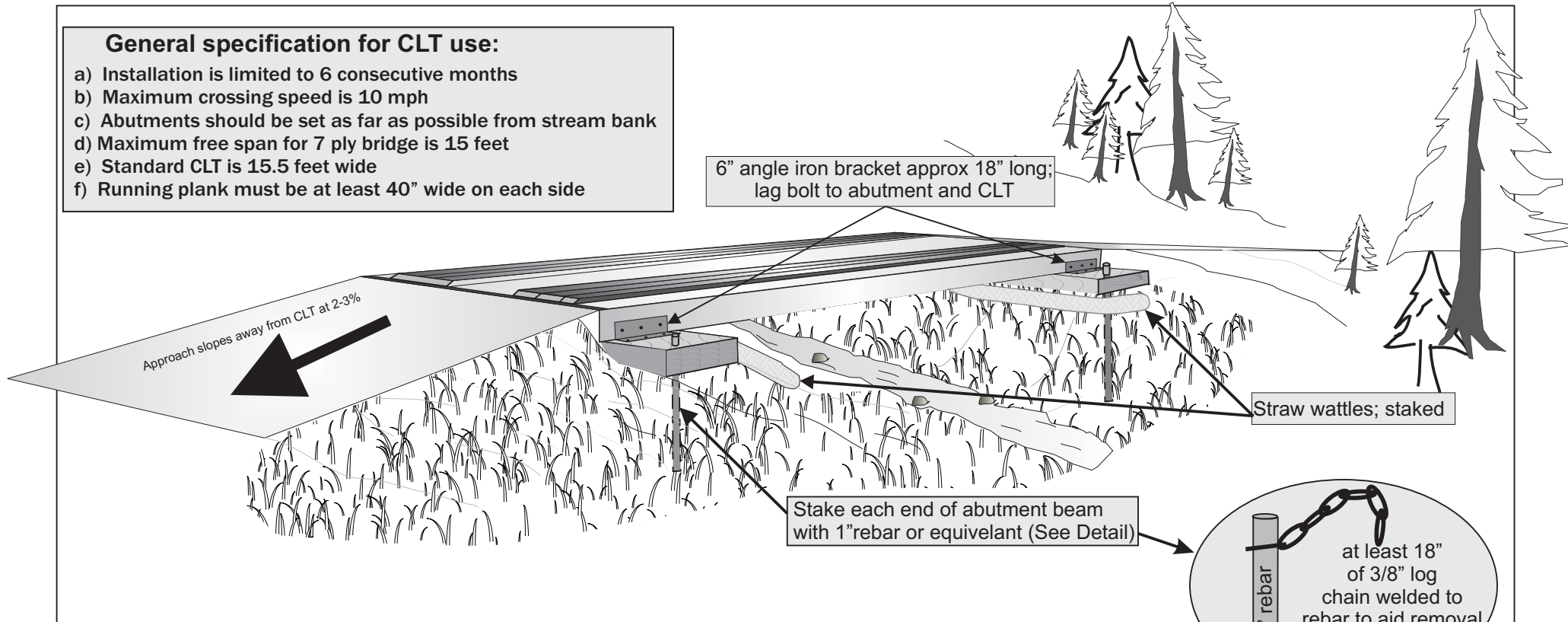

\* free span varies by engineered design. Check with Forest Officer



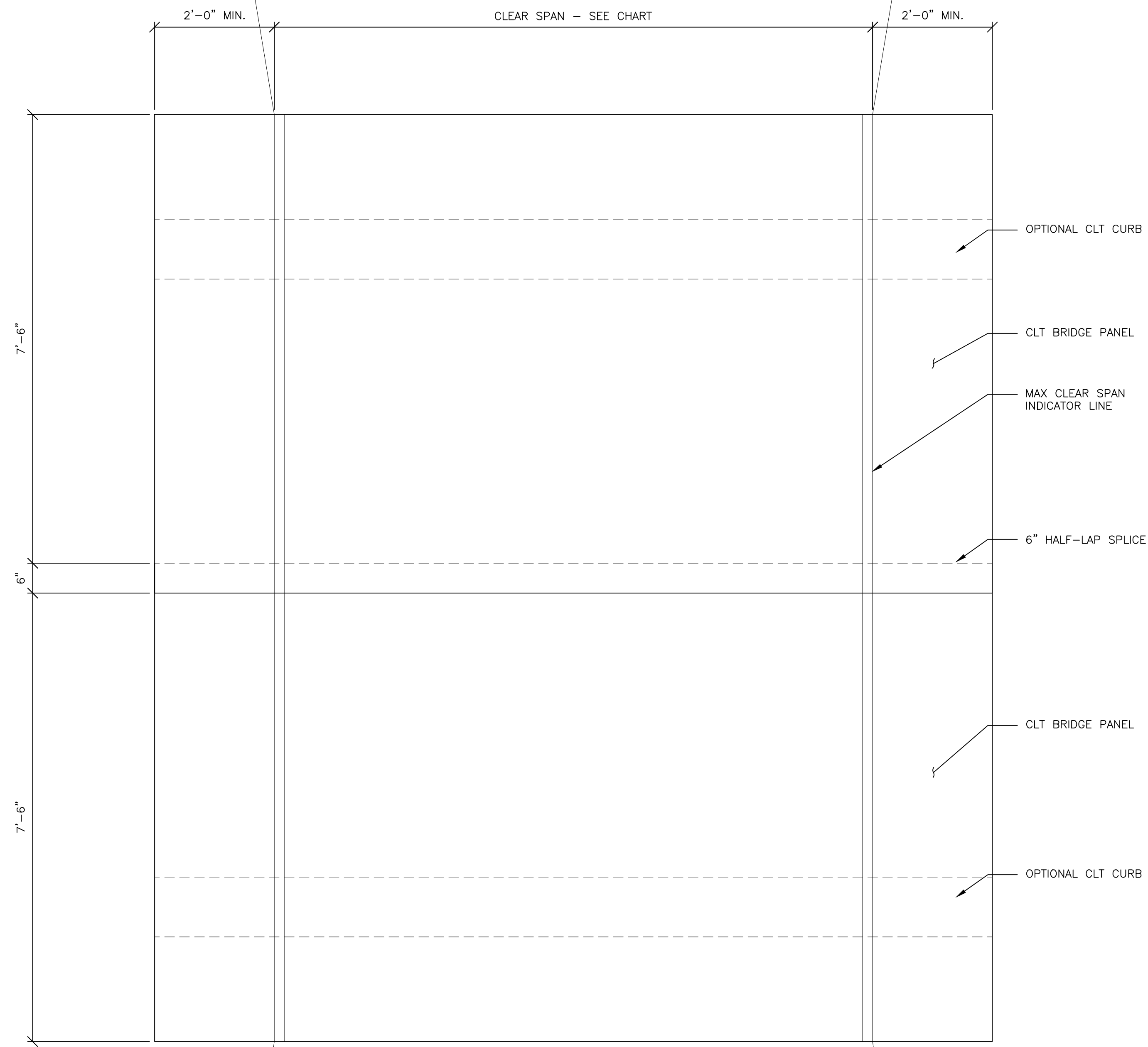

CLT BRIDGE PLAN

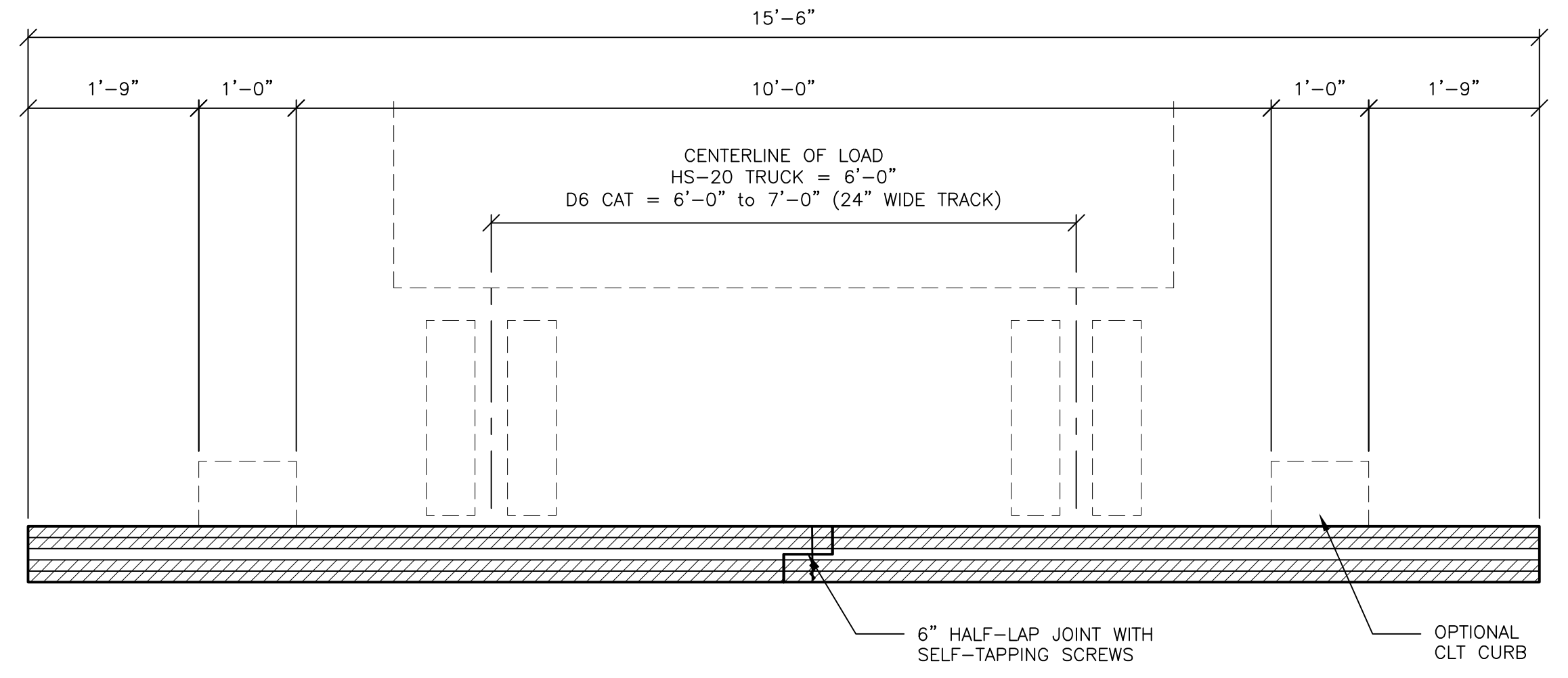

CLT BRIDGE SECTION

CLT BRIDGE SPAN CHART

CLT SECTION	MAX. SPAN (FEET)	NOTES
4 PLY	4'-0"	
5 PLY MAX.	6'-0"	
7 PLY MAX.	15'-0"	

- SCHEDULE NOTES:**
- ALL MATERIAL SHALL BE DOUGLAS-FIR/LARCH NO.2 OR BETTER.
  - CLT SECTION PROPERTIES CALCULATED IN ACCORDANCE WITH THE CLT DESIGN HANDBOOK AND APA PRG-320.
  - ADJUSTMENT FACTORS:
    - Cd = 1.25 (CONSTRUCTION LOADING)
    - Cm = 0.85 (MOISTURE EXPOSURE)
  - MAX SPAN BASED ON HS-20 LOADING AND EFFECTIVE CLT SECTION PROPERTIES.

- GENERAL DESIGN AND MANUFACTURING NOTES:**
- DEFINITIONS
    - CLT - CROSS LAMINATED TIMBER AS DEFINED IN THE REFERENCE STANDARDS.
  - REFERENCE STANDARDS
    - US EDITION CLT DESIGN HANDBOOK, 2013
    - APA PRG-320 - STANDARD FOR PERFORMANCE RATED CLT
  - DESIGN CRITERIA
    - HS-20 LOADING
      - 18,000 LB WHEEL LOAD
      - 64 PSF LANE LOAD
  - MATERIAL
    - MATERIAL SHALL BE DOUGLAS-FIR/LARCH NO.2 OR BETTER FOR ALL PLYS.
    - GLUE SHALL MEET SPECIFICATIONS OUTLINED IN REFERENCE STANDARDS.
  - MANUFACTURING
    - CLT PANELS SHALL BE MANUFACTURED IN ACCORDANCE WITH THE CLT HANDBOOK AND APA PRG-320 INCLUDING ALL REFERENCED REQUIREMENTS IDENTIFIED IN THE STANDARDS.
    - CLT SECTION PROPERTIES SHALL BE CALCULATED IN ACCORDANCE WITH THE CLT HANDBOOK.
  - SUBMITTALS
    - MANUFACTURER SHALL SUBMIT CERTIFICATION THAT THE CLT PANELS PROVIDED MEET OR EXCEED THE DESIGN CRITERIA AND MANUFACTURING REQUIREMENTS OUTLINED IN THESE NOTES.

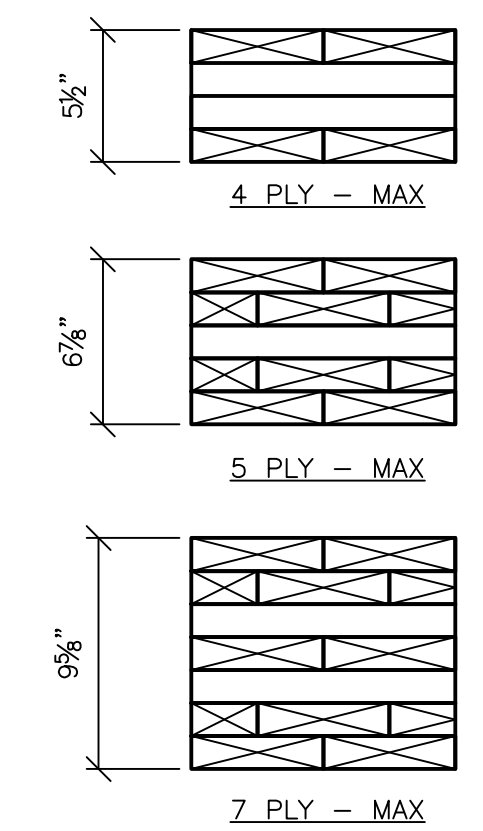

CLT LAYUP COMBINATIONS

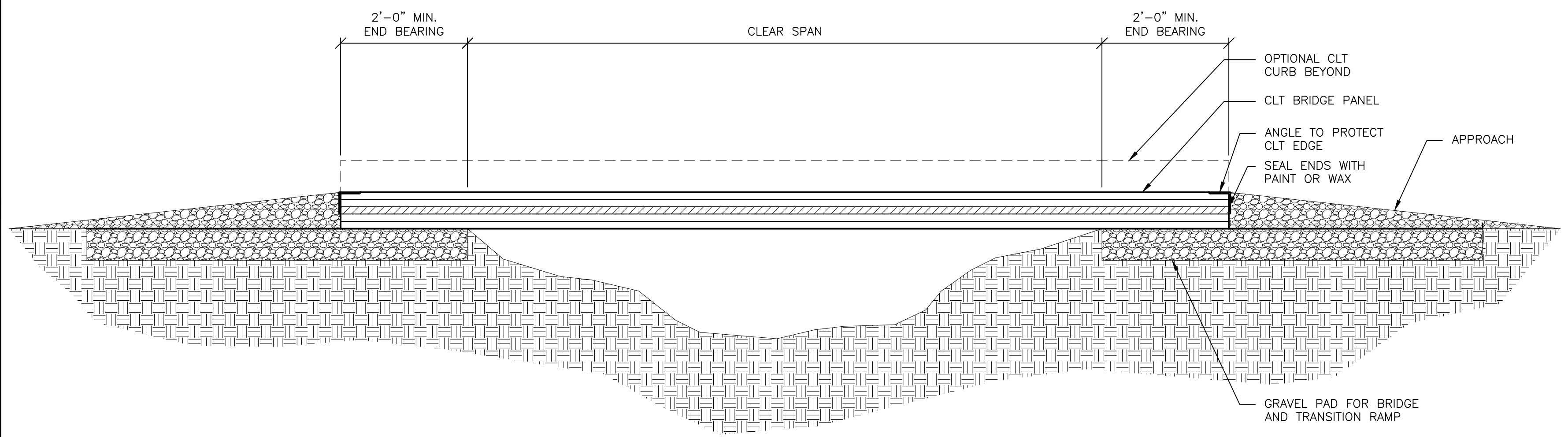

CLT BRIDGE PROFILE

DNRC TIMBER SALE  
TEMPORARY CLT BRIDGE

PLAN, PROFILE &  
SECTIONS

DRAWN | CHECKED | REVISED | REVISED

ISSUED FOR REVIEW - NOT FOR CONSTRUCTION

14.01.126  
03.18.2014

SHEET

S1.0



# BRIDGE SITE REHABILITATION

Remove bridge materials and dispose outside of SMZ at a location directed by the Forest Officer. Solid logs may be spread on the road surface for stability and to aid in closure.

Build sediment fence at edge of stream before crib logs are removed. After bridge removal and resloping, armor with talus above fence for 5 feet, then seed the remaining exposed fill slope.

Lay back approach fill at 2:1 ratio. Dispose of excess material as berm to close road

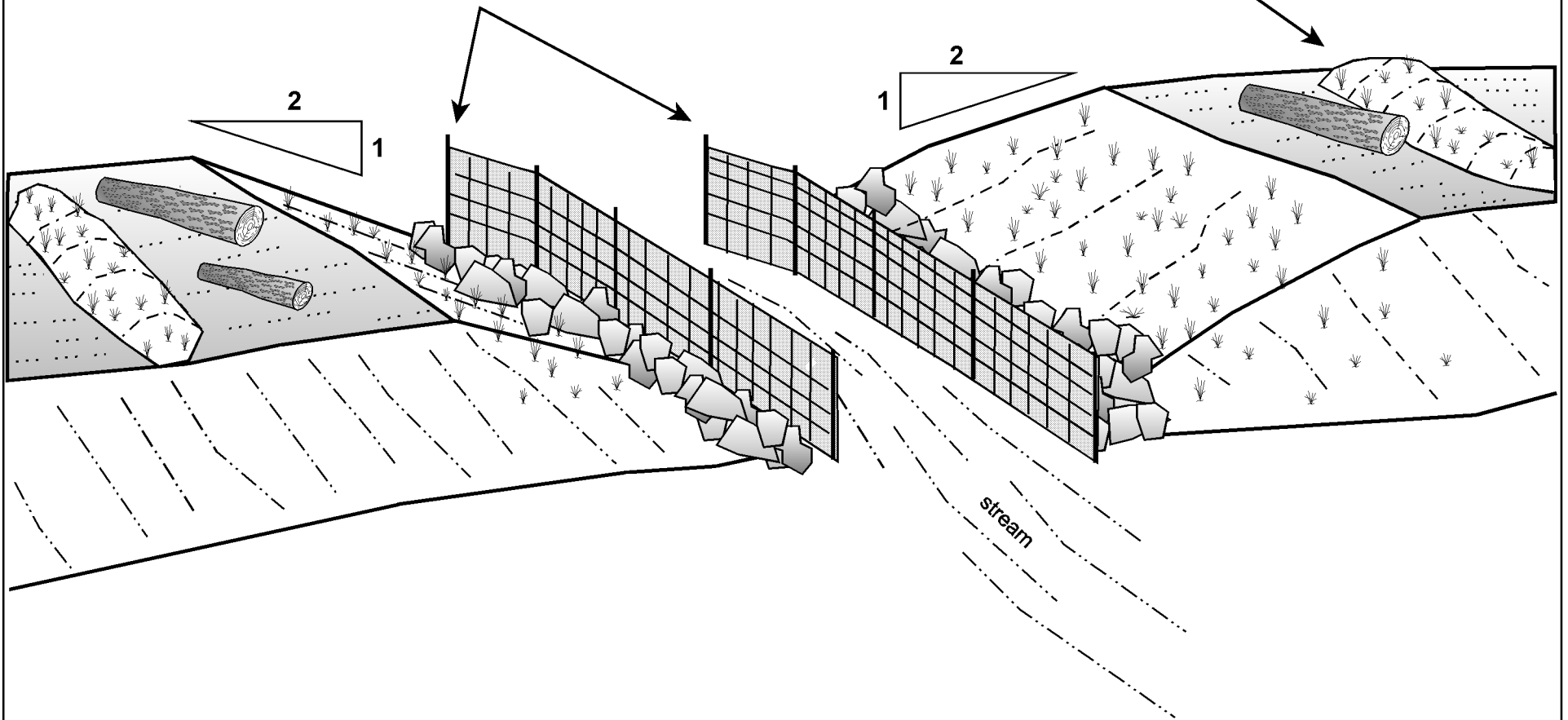

# SWITCHBACK REQUIREMENTS

Attachment B

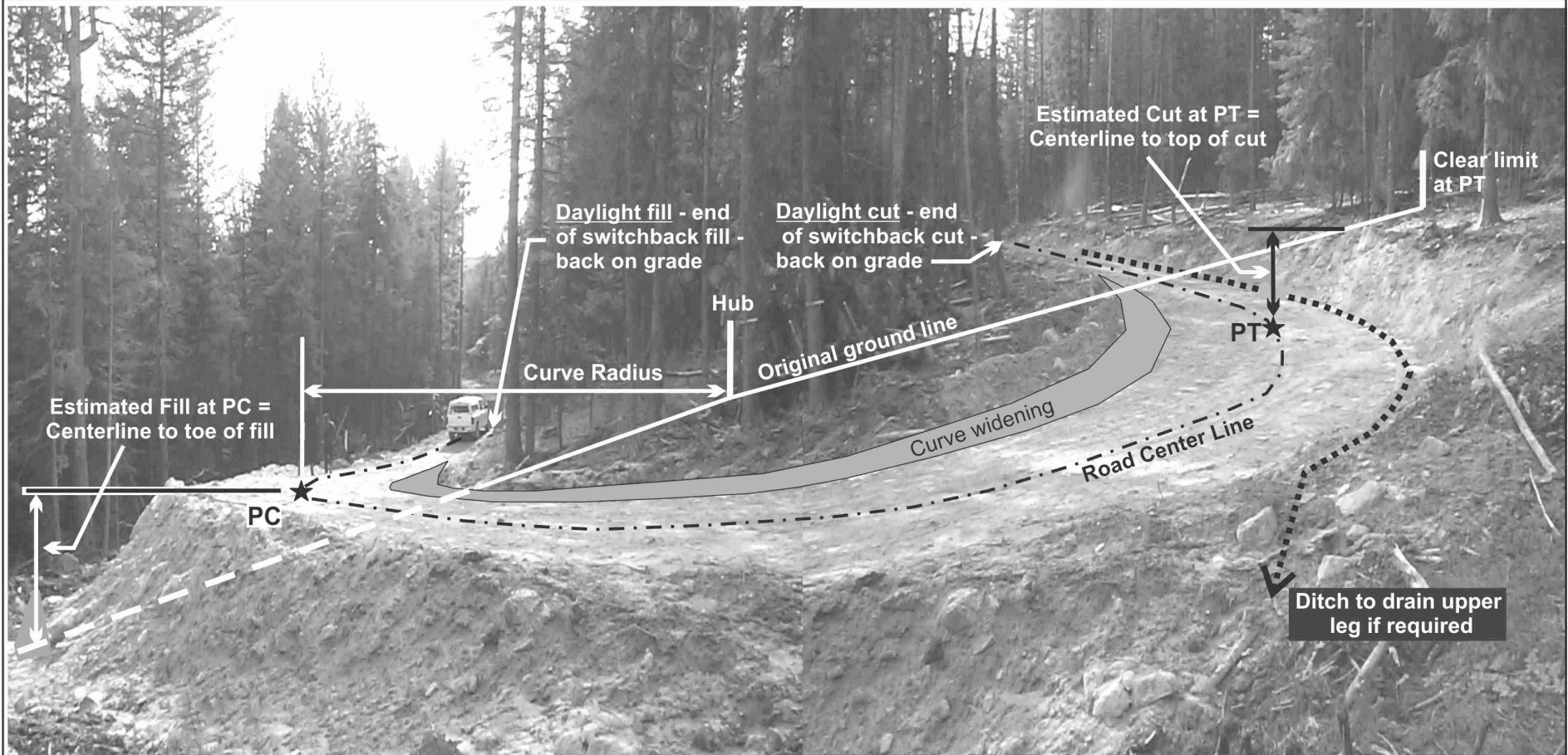

## Specifications

Grade through curve - PC to PT:	<u>+4%</u>
Grade from PC to daylight fill:	<u>+6%</u>
Grade from PT to daylight cut:	<u>+6%</u>
Estimated fill depth at PC = centerline to toe of fill:	<u>8.2'</u>
Estimated cut depth at PT = centerline to top of cut slope:	<u>6.5'</u>

## Cross Section View Through Hub

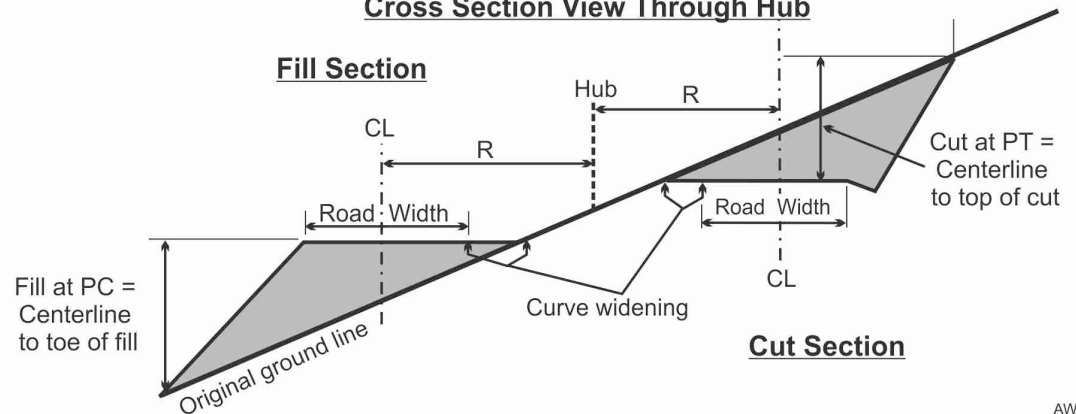

# FOREST FIRE RULES & REGULATIONS

These rules apply to all activities on all classified forest lands within Montana during the legal Forest Fire Season, including any extension thereof (see 77-5-103(3), 76-11-101, 76-13-102(7), and 76-13-109 MCA). Reference also ARM 36.10.119 through 132.

Related State statute numbers are provided as a reference.

## RULE I - DEBRIS BURNING

1. The person conducting the burn shall obtain written authorization from the recognized fire protection agency before igniting any open fire during the legal forest fire season (required by 76-13-121 MCA). The recognized fire protection agency may deny, restrict, or rescind any authorization by notifying the person conducting the burn.
2. All burning must comply with the Department of Environmental Quality or State/county/local open burning regulations.
3. Written authorization is not required for campfires.

## RULE II - CAMPFIRES

1. Campfires cannot be left unattended and must be completely extinguished (see 76-13-123 MCA).
2. All campfires must be constructed in cleared or bare areas, and not allowed to spread beyond the established ring, pit, grate, or container.
3. Anyone igniting a campfire is required to have fire tools listed in Rule VIII (4).

## RULE III - RAILROADS AND POWERLINES

Railroad and powerline companies are required to prepare and annually update working agreements with recognized fire protection agencies. These agreements must stress safety and fire response procedures; and identify, remove, prevent, modify, abate, or correct forest fire hazards and risks associated with railroad and powerline company operations (see 69-14-721 MCA).

## RULE IV - EQUIPMENT

1. All internal combustion engines must be equipped with an approved and effective spark-arresting system, as established in the National Wildfire Coordinating Group's Spark Arrester Guides. Spark-arresting devices must be marked, properly installed, and maintained in accordance with the Guides. The following vehicles are exempt:
  - a. automobiles and light trucks of less than 23,000 GVW when all exhaust gases pass through a properly installed and maintained exhaust system, baffle-type muffler, and tailpipe. Vehicles with glass-pack mufflers do not qualify for the exemption.
  - b. heavy-duty trucks of 23,000 GVW or greater, with a muffler and vertical stack exhaust system extending

above the cab.

- c. vehicles with other spark-arresting systems providing equal or increased effectiveness. Such vehicles must be inspected and have written authorization from the recognized fire protection agency.
2. Equipment used for commercial, ranching, or industrial activities must meet the fire extinguisher and tool requirements listed in Rule VIII (5).

## RULE V - FLAMING AND GLOWING SUBSTANCES

1. All flaming and glowing substances, including but not limited to, lighted cigarettes, cigars, ashes, and matches, must be extinguished before being discarded (see 76-13-124 MCA).
2. Smoking is allowed only at areas free of flammable or combustible material. Examples of these areas include a graveled road or an enclosed vehicle.

## RULE VI - FIREWORKS

Use of fireworks is prohibited on all classified forest lands unless written authorization is obtained from the recognized fire protection agency. Authorization will only be considered between June 24 and July 5, inclusive, to coincide with the legal dates for the sale of fireworks in Montana (see 50-37-106 MCA).

## RULE VII - WILDLAND/URBAN INTERFACE

1. County governments without subdivision wild-fire protection standards are encouraged to establish standards for all new subdivisions by January 1, 2000.
2. The Fire Protection Guidelines for Wildland/Residential Interface Development (DSL/DOJ, 1993) is available for use to assist counties in the development of standards.

## RULE VIII - FIRE EXTINGUISHERS AND FIREFIGHTING TOOLS

1. Chainsaw operators shall carry a fully charged and operable fire extinguisher, minimum-capacity 8-ounce liquid or 1-pound dry chemical, with a 4BC or higher rating.
2. Vehicles and equipment, mobile or stationary, with a combustion engine/motor used for commercial, ranching, or industrial activities must have one operable, dry-chemical fire

extinguisher with a minimum 2-1/2 -pound capacity and 4BC or higher rating.

3. Chainsaw operators shall maintain one usable shovel at chainsaw-fueling sites.
4. All persons or parties igniting a campfire shall have one usable shovel and bucket. Persons igniting a barbecue need not have a shovel or bucket if the ashes are not removed from the container and the ashes or container are not placed on or near combustible material.
5. All commercial, ranching, or industrial activities must have:
  - a. one usable shovel or pulaski with each vehicle and equipment with an internal combustion engine/motor, mobile or stationary.
  - b. one backpack pump with each vehicle and with any equipment, used off road, mobile or stationary, with an internal combustion engine/motor, that cannot be used to build fireline and is being operated on combustible material.
6. Other types of firefighting tools that provide increased efficiency or effectiveness may be substituted by written authorization from the recognized fire-protection agency. For example, a [combi] firefighting tool may be substituted for a shovel or pulaski.

#### RULE IX - FOREST ACTIVITY RESTRICTIONS

In areas designated by public proclamation by the administrator, division of forestry, as areas of high fire hazard, the administrator may request all persons, firms, or corporations present or engaged in any activity in the areas to voluntarily cease operations or to adjust working hours to less critical periods of the day. In the event such a request is refused, the administrator may issue a written order directing compliance.

#### RULE X - FOREST CLOSURE

1. During periods of dangerous fire conditions, no person may enter or be upon those forest lands designated by public proclamation by the governor of the state of Montana as areas of dangerous fire hazard except under written permit issued by a recognized agency.
2. Permits to enter upon such areas during the closure may be issued by the recognized agency upon a showing of real need by the applicant. Permits may be issued to those persons having actual residence as a permanent or principal place of abode in the forest lands designated or to persons engaged in non-fire hazardous employment.
3. However, no permit may be required of persons engaged in either firefighting, fire prevention, or law enforcement who are engaged in official business.

#### RULE XI - CORRECTION OF HAZARD AND UNUSUAL CIRCUMSTANCES OR EVENTS

The recognized fire-protection agency may require identified wildland-fire hazards and/or risks be halted, prevented, abated, removed, disposed of, mitigated, or patrolled. This applies to public, private, nonprofit, commercial, and/or residential circumstances or events.

#### RULE XII - REQUEST FOR REVIEW

If any operator believes that in his case any requirement of a recognized agency is excessive, the operator may request the administrator, division of forestry, to review the requirements. If in the opinion of the administrator any or all are not necessary in the interest of public safety, he may make such changes as he considers advisable.

#### RULE XIII - DEFINITIONS

**Backpack Pump:** 5-gallon minimum; standard galvanized metal, fiberglass, or rubberized backpack water container with attached handpump; full of water at all times.

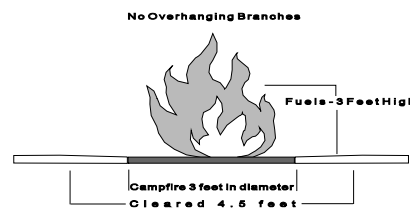

**Bucket:** Metal, plastic, canvas, or fiberglass container capable of holding at least one gallon of water. Motorcycle helmets qualify. **[Campfire]** means a fire set for cooking, warming, or ceremonial purposes; not more than 3 feet in diameter or height; void of overhanging branches; with all combustible material cleared at least 1-1/2 times the diameter of the fire; or a barbecue in a noncombustible container.

**Combi Tool:** A tool combining a shovel and pick.

**Fireworks:** As defined in 50-37-101 MCA.

**Forested Land:** As defined in 76-13-102 MCA and 36.10.101 ARM.

**Hazard:** Condition that promotes the ignition and/or spread of a wildland fire.

**Open Fire:** The burning of a bonfire, rubbish fire, or other fire in an outdoor location where fuel being burned is not contained in a closed incinerator, or outdoor fireplace. Barbecue pits and burn barrels are considered open fires and therefore require a burning permit (Rule I).

**Pulaski:** An ax with a medium size sharp grub hoe opposite the ax blade.

**Recognized Fire-Protection Authority:** An agency organized for the purpose of providing fire protection and recognized by the board as giving adequate fire protection to forest lands in accordance with rules adopted by the board.

**Risk:** Action or device that could cause a wildland fire to ignite.

**Shovel:** Vehicle, equipment, and chainsaw operator shovels will have a minimum overall length of 36 inches with a round pointed shovel head with a minimum width of 6 inches. Shovels required for campfires must be at least 24-inches in length with a pointed shovel head. Folding handles qualify.

#### RULE XIV - APPLICABILITY

The forest fire rules, Rule I through Rule XIII, (ARM 36.10.119 through 30.10.132) are in effect each year on classified forest land during the forest fire season May 1st to September 30th inclusive, or any legal extension thereof. Requirements pertaining to motor vehicles do not apply to those being operated solely on roads that are a part of federal or State maintained highway systems or on any paved public road.



# WORKING IN BEAR HABITAT

12/03/12

Grizzly bear distribution is expanding in Montana and human/bear encounters are becoming more common. Working in bear habitat increases the likelihood of interactions with bears. It is important for contractors and their employees to be aware of steps that can be taken to minimize conflicts and how to react if an interaction occurs. This pamphlet provides information about bear behavior, preventive measures, and what to do in the event an encounter occurs. *This pamphlet is intended to provide information about possible ways of avoiding encounters with bears. It should not, however, be relied on as the sole means of doing so. In addition to adhering to the guidelines outlined in this document, you should always rely on your experience, training, education and judgment about the best, safest manner to avoid encounters with bears.*

## ENCOUNTERS

- ▲ Stay calm and keep the animal in view, but avoid direct eye contact. Bears may interpret eye contact as a sign of aggression. Back away slowly. Never run from a bear unless you know you can reach safety. Determine whether the animal is a black bear or a grizzly bear.
- ▲ If the bear charges, stand your ground. Bears commonly “bluff charge,” stopping within a few feet of a person, before fleeing in a different direction.
- ▲ Keep bear spray handy. Always have a canister of bear spray (at least eight ounces) on your belt. Make sure it is an EPA registered bear spray with 1 to 2% capsaicin and related capsaicinoids, has a spray duration of at least six seconds, and a range of 25 feet. Familiarize yourself with the directions for using the spray. Use it only if confronted by a charging bear. Spray toward the bear, aiming slightly downward.
- ▲ In the event that you have no bear spray, or it was ineffective and the charge is not a bluff, or the bear is exhibiting predatory behavior, you must change your approach. Signs of predatory behavior include: following, showing interest, coming into a tent, and unprovoked attacks. How you respond will depend on the species of bear attacking you. **Black bear and young grizzly attacks:** Always fight back. Jump up and down, wave your arms and yell. Try to look as large as possible. Never play dead – it makes you easier prey. Remember that black bears and small grizzlies can climb trees, so stay on the ground. **Mature grizzly attacks [particularly females with young]:** If a surprise encounter occurs or if bear spray is ineffective, drop to the ground and play dead. Lie on your stomach, clasp your hands behind your neck, and use your elbows and toes to avoid being rolled over. If the bear rolls you over, keep rolling until you land back on your stomach. Remain still and don't struggle or scream. A defensive bear will stop attacking once it feels the threat is gone. Don't move until you are sure the bear has left the area. **If the grizzly is exhibiting predatory behavior or comes into a tent at night, do all you can to escape or fight back.**
- ▲ **If an encounter occurs, contact the DNRC forest officer immediately and notify Montana FWP.**

## JOB SITE PREVENTION

- ▲ Watch for bear signs. Signs include: tracks; droppings; recently overturned rocks or logs; logs torn apart; clawed, bitten or rubbed trees; bear trails; hair on tree bark; fresh diggings; and crushed vegetation. If you observe any of these signs, be aware that a bear may be frequenting the area. If camping, or stopping to eat your lunch, select a different area.
- ▲ When working or walking alone, make noise and carry bear spray. Bears don't like surprises, but will move on if they hear people approaching. Make noise, especially when approaching blind corners, dense shrubs and streams, and when walking into the wind. Maintain regular communication with co-workers.
- ▲ If camping on site, leave coolers, food and beverages inside campers or secured vehicles. If cooking over an open fire, do not discard food or grease in fire pits.
- ▲ Don't leave trash, groceries or animal feed in your vehicle for extended periods. Bears can, and do, pry open car and truck doors and break windows to get at food and other items they associate with food.
- ▲ Bears are attracted to petroleum based products. Keep all fuel and oil canisters in bear resistant containers. Bears have been known to damage hoses, oil filters and foam seats on heavy equipment. Dispose of empty containers promptly.



# Montana Fish, Wildlife & Parks

Fisheries Management, 730 ½ N. Montana, Dillon, MT 59725  
Phone: (406) 683-9310 Fax: (406) 683-4126 email: mattjaeger@mt.gov

## Stream Protection Act (SPA 124) Permit

Date: 8 August 2023

Applicant Name: Riley Stevenson

Address: Montana DNRC  
840 N. Montana  
Dillon, MT 59725

Permit #: MISC 6-24 R3

Waterbody: West Fork of Blacktail Creek

Project Name: West Fork of Blacktail Creek temporary bridges

### Project Description:

The project purpose is to install two temporary 30' CLT bridges to provide access to and hauling routes from a timber sale east of the West Fork of Blacktail Deer Creek.

**Montana Fish, Wildlife & Parks has reviewed the proposed project. The project is approved provided it is carried out in accordance with the information supplied in the application, all general conditions listed on page 3 of this permit, and any special conditions listed below.**

**Expiration:** This permit is valid for 1 year(s) from the date of issuance.

**Timing Restrictions:** No  Yes  if yes see below.

No in-stream work between \_\_\_\_\_ and \_\_\_\_\_

**Special Conditions:**

- 1) The bridges should be installed and removed during baseflow or dry channel conditions with flowing waters isolated from sediment and road fill input by staking straw wattles adjacent to the stream prior to abutment construction and removal.
- 2) Approaches shall be constructed to rise to and drain away from the bridge such that no sediment can run down the road and onto the bridge.
- 3) Following bridge removal, any existing road fill in the floodplain shall be removed and the area contoured to match the existing floodplain and revegetated with an emphasis on dormant transplanted native sod mats and/or an approved native species seed mix. Coconut fabric should be used in conjunction with seeding on steep grades to reduce sedimentation.
- 4) Provide FWP with pictures of each bridge following installation and removal.

**318 Authorization Review**

**I have reviewed the above project on behalf of the Montana Department of Environmental Quality (DEQ) pursuant to the Montana Water Quality Act Short-term Water Quality Standards for Turbidity 75-5-318 MCA:**

- This project **will not** increase turbidity if completed according to the conditions listed in the 310 or 124 permit. Therefore, application to DEQ for a 318 authorization **is not** required.
- Impacts to the physical and biological environment from turbidity generated as a result of this project are uncertain. Therefore, the applicant must contact the Montana Department of Environmental Quality, 1520 East Sixth Avenue, Box 200901, Helena, MT 59620-0901, (406 444-3080) to determine project specific narrative conditions required to meet short-term water quality standards and protect aquatic biota.
- Turbidity generated from this project is expected to be short-term and have only temporary and minor impacts on the physical and biological environment. Therefore, compliance with the conditions stated in the attached letter outlining ***DEQ's Short Term Water Quality Standard for Turbidity Related to Construction Activity***, as well as other conditions listed in the 310 or 124 permit, are appropriate for this project.

Issuing Biologist: Matthew Jaeger

Signature: 

### **Stream Protection Act 124 Permit General Conditions**

1. Complete work affecting a streambed or stream bank in an expeditious manner to avoid unnecessary impacts to the stream.
2. Limit the clearing of vegetation to that which is absolutely necessary for construction of the project. Take precautions to preserve existing riparian vegetation. Salvage and reuse native vegetation where possible.
3. Install and maintain erosion control measures where appropriate to protect aquatic resources. Do not clear and grub land adjacent to streams prior to installing proper erosion and sedimentation controls. Conduct all work in a manner that minimizes turbidity and other disturbances to aquatic resources.
4. Plan temporary construction facilities to:
  - a. Minimize disturbance to stream banks, stream bank vegetation, and the streambed by locating staging or storage facilities at least 50' horizontally from the highest anticipated water level during construction;
  - b. not restrict or impede fish passage in streams; and
  - c. not restrict any flow anticipated during use.
5. Provide sediment controls for drainage from topsoil stockpiles, staging areas, access roads, channel changes, and instream excavations.
6. Isolate work zones from flowing and standing waters to prevent turbid water and sediments from being discharged into streams or other drainages that flow directly into the stream. Divert flowing waters around the work zone.
7. Do not spill or dump material into streams. Store and handle petroleum products, chemicals, cement and other deleterious materials in a manner that will prevent their entering streams.
8. Do not permit wash water from cleaning concrete-related equipment or wet concrete to enter streams.
9. Do not operate mechanized equipment in any stream or flowing water unless special authorization is obtained. If special authorization is granted, the following conditions apply:
  - a. Powerwash all equipment allowed in a stream prior to entering the stream channel.
  - b. Clean and maintain all equipment so that petroleum-based products and hydraulic fluids do not leak or spill into the waterway.
10. Reclaim streambeds and stream banks as closely as possible to their pre-disturbed condition.
11. Restore disturbed stream banks to their natural or pre-disturbed configuration to match adjacent ground contours or as specified in the project plans. Stabilize, reseed, and re-vegetate disturbed areas. Install and maintain long-term biodegradable erosion-control measures to protect these areas until adequate vegetation has been established.
12. Restore temporary access routes and any temporarily disturbed areas to original conditions, including original contours and vegetation.
13. Dispose of any excess material generated from the project above the ordinary high water mark and in an area not classified as a wetland.





**SHORT-TERM WATER QUALITY STANDARD  
FOR TURBIDITY RELATED TO  
CONSTRUCTION ACTIVITY  
(318 Authorization)**

Dear Applicant:

This 318 authorization is the result of your recent application for a 310 permit from your local Conservation District or a 124 permit from Montana Fish, Wildlife and Parks. This authorization is valid for the time frame noted on your permit.

**This is not your 310 or 124 permit and no construction activity should occur until you have received a valid 310 or 124 permit as well as any other permits that apply to this proposed construction activity.**

This authorization is the result of an Operating Agreement between the Montana Department of Environmental Quality (DEQ), and Montana Fish, Wildlife and Parks (FWP).

The applicant agrees to comply with the conditions stated below, as well as other conditions listed in the 310 or 124 permit issued for this project. Signatures of the applicant and FWP are required to validate this authorization.

1. Construction activity in or near the watercourse are to be limited to the minimum area necessary, and conducted so as to minimize increases in suspended solids and turbidity that could degrade water quality and adversely affect aquatic life outside the immediate area of operation.
2. The use of machinery in the watercourse shall be avoided unless absolutely necessary.
3. All disturbed stream banks and adjacent areas created by the construction activity shall be protected with erosion control measures during construction. These areas shall be reclaimed with appropriate erosion control measures and revegetated to provide long-term erosion control.
4. Any excess material generated from this project must be disposed of above the ordinary high water mark, in an area not classified as a wetland, and in a position not to cause pollution of State waters.
5. Clearing of vegetation will be limited to that which is absolutely necessary for construction of the project.
6. This authorization does not authorize a point source surface water discharge. MPDES permit is required for said discharge.
7. Open cut creek crossings will not be allowed in flowing water. Stream water must be diverted around the open cut area (pump, flume etc.)
8. The applicant must conduct all activities in full and complete compliance with all terms and conditions of all permits required for this activity issued pursuant to the Montana Natural Streambed and Land Preservation Act (310 permit), the Stream Protection Act (124 permit) the Federal Clean Water Act (404 Permit), any MPDES permits for dewatering or storm water control in the construction area and any valid Memorandum of Agreement and Authorization (MAA) negotiated for this activity.

The FWP representative has determined that this project is within the scope of the programmatic Environmental Assessment prepared by DEQ and FWP for the issuance of narrative turbidity standards.

  
Date: 9 April 2024  
FWP Representative's Signature

\_\_\_\_\_  
Date: \_\_\_\_\_  
Applicant's Signature

Name and location of project: West Fork of Blacktail Creek temporary bridges MISC 6-24 R3

**Attachment G**

**Designation by Description – Blacktail Again Timber Sale**

**Designation by Description Guidelines**

The following silvicultural treatments will be applied to the identified Units within the sale area to create a diverse residual stand using traditional even-aged management;

- a) **Shelterwood Method (SW)** Douglas-fir selected for retention will exhibit a resistance to spruce budworm infestation with well-formed healthy crowns, showing good vigor and generally good health. Up to half acre openings may occur where suitable leave trees are not present. Groups of healthy trees can be selected for retention creating a natural group reserve. Two snags and two snag recruits per acre will be retained.
  
- b) **Seed Tree Method (ST)** Trees selected for retention will exhibit a resistance to spruce budworm infestation with well-formed healthy crowns, showing good vigor and generally good health. Groups of healthy trees can be selected for retention creating a natural group reserve. Two snags and two snag recruits per acre will be retained.
  
- c) **Overstory Removal (OSR)** will be applied to units where prior seed tree harvest systems have been conducted in the past, leaving an open mature Douglas fir overstory stand. The goal is to reserve natural regeneration while removing overstory trees that have been impacted by spruce budworm. Two snags and two snag recruits per acre will be retained. Leave tree spacing will be variable across unit.

**Specific Harvest Prescription by Unit:**

<b>Unit #</b>	<b>RX</b>	<b>Target TPA</b>	<b>Target Spacing (ft)</b>
1	SW	20	47
2	SW	29	39
3	SW	38	34
4	SW	27	40
5	SW	24	43
6	SW	34	36
7	ST	15	54
8	ST	15	54
9	OSR	4	104
10	SW	30	38